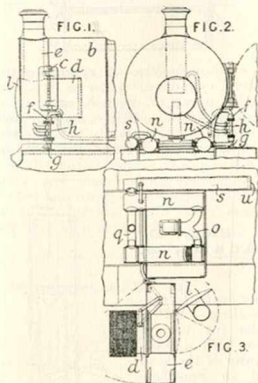
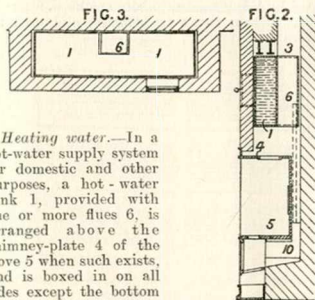


portion *e* of the smoke-box *b* through a rotatable connexion consisting of a pipe *h* divided to form inlet and outlet passages and mounted in stuffing-boxes *f*, *g* in line with the hinge *c*.



In a modification, the hinge itself is adapted to provide the necessary steam and water connexions. The exhaust-steam heaters *n* are connected at one end to the exhaust pipe *o* and at the other end to the T-shaped blast-pipe *q*. A supplementary heater *s* provided with a drain-cock prevents undue condensation in the heaters *n*. The supplementary heater may be heated by passing live steam into a jacket *u* when the regulator is closed.

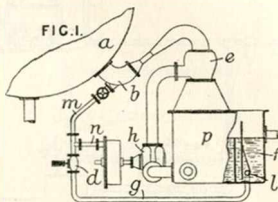
28,272. **Smither, W. H.** Dec. 15.



*Heating water.*—In a hot-water supply system for domestic and other purposes, a hot-water tank 1, provided with one or more flues 6, is arranged above the chimney-plate 4 of the stove 5 when such exists, and is boxed in on all sides except the bottom by the brickwork of the

chimney. The tank flue or flues 6 lead into the chimney flue 3. If desired, the tank may be connected to the ordinary boiler 10 by flow and return pipes.

28,679. **Morison, D. B.** Dec. 20.

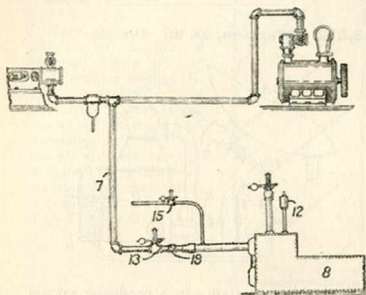


*Feed-water heating.*—In a condenser system in which air is primarily withdrawn from a condenser *a* by means of a steam-jet *b* and is afterwards discharged to the atmosphere by a suitable device, for example a water-jet ejector *e*, a preferential supply of exhaust steam is delivered to the steam-jet *b*, and any excess of steam is admitted to the feedwater-heater. In one form of apparatus, the exhaust from a turbine driving a pump *h*, which supplies water to the ejector *e*, is passed through pipes *n*, *m* to the steam jet *b*. The excess steam passes through a springloaded valve *d*, pipe *g*, and nozzle *l* to the feed-heating compartment *f* of the water-tank *p*. The feed-heater may be fitted with a float which regulates the supply of excess steam, and, if desired, the discharge of the heated water, or the passage of the water back into the condenser or into other cooling-means; a thermostatic control of the excess steam supply may also be adopted. The feed-heater may be of the construction described in Specification 11,690/10, or may be a surface-apparatus. The feed-heater may be separate from the water-tank *p*, and be fed with water from the pump *h* through a valve controlled by a float in the tank *p*.

28,841. **Wharton, J. S. L., Hallowell, W. S., and Jones, J. C.,** [trading as Harrison Safety Boiler Works]. Dec. 21.

*Heating water.*—A system for utilizing exhaust steam partly in a heater, such as a feed-water heater, and partly in a low-pressure prime mover, such as a turbine, is provided with valves which ensure the desired supply of steam to the heater and allow surplus steam to pass to the low-pressure prime mover. Live steam is admitted automatically to the heater when the exhaust supply is insufficient. The heater and the turbine are connected to the exhaust line in parallel. A valve 13 in the pipe 7 conveying

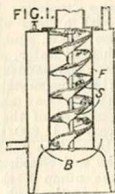
exhaust steam to the heater 8 reduces the pressure of the steam entering the heater to a predetermined pressure. When the steam falls



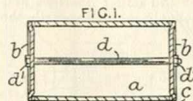
below that pressure, the valve 13 or a non-return valve 19 closes, and a valve 15 in a live-steam pipe connected to the pipe 7 opens. A non-return valve only may be fitted in the pipe 7. The heater is provided with a relief valve 12.

**28,996. Wilson, C. L.** Dec. 23.

*Vertical boilers.*—In a gas-heated boiler B having one or more flues F, a spiral baffle S is arranged, having its face curved downwards from the outer edge to the centre. This baffle may be made in sections, as shown, or in one piece, and the flue F may be plain, corrugated, or spirally grooved.



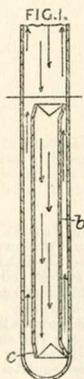
**29,011. Stimson, E. F.** Dec. 23.



*Kitchen-range boilers.*—A cylindrical or approximately cylindrical boiler a is closed at each end by a cap or cover b, one or both of which are detachable. They may be held in place by a bolt d with nuts d'. Suitable washers c may be interposed between the body a and the cap b.

**29,240. Sidey, D., and Adams, A.** Dec. 29.

*Heating water; feed-water, heating.*—A Perkins tube for use in connexion with a feed-water-heater of the kind described in Specification 27,765/07, [Class 123, Steam generators], is fitted internally at the heated portion with a smaller open-ended tube b for promoting circulation. The inner tube is held concentrically by enlarged triangular ends c.



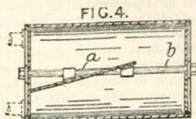
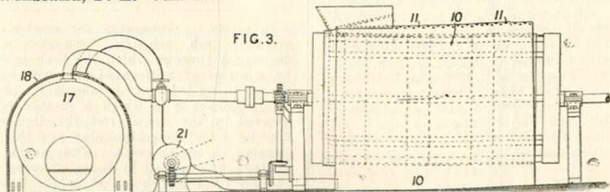
**29,346. Mellor, T.** Dec. 30. *Drawings to Specification.*

*Feed-water, heating.*—Water which has been heated by being used to purify smoke, is filtered, heated further in an economizer, and used as feed-water.

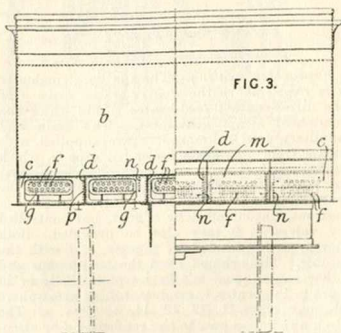
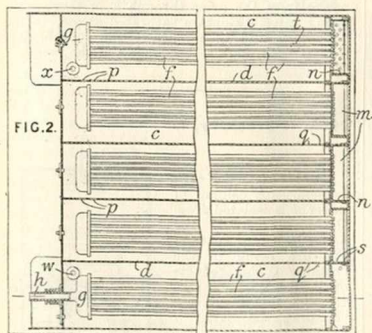
A.D. 1912.

52. **Stimson, E. F.** Jan. 1.

*Kitchen-range boilers.*—One or more horizontal or, as shown in Fig. 4, inclined baffles *a* are fitted in the water space of a cylindrical or approximately cylindrical boiler so as to lengthen the flow of water through the boiler. The baffles are described as applied to boilers constructed according to Specification 29,011/11 comprising cylindrical shells with end plates held together by a central bolt *b*.

353. **Winsland, F. E.** Jan. 4.

*Heating air.*—Air is drawn by a fan 21 from the atmosphere through the space between a boiler 17 and its casing 18 and is passed into the casing 10 of a drying-cylinder.

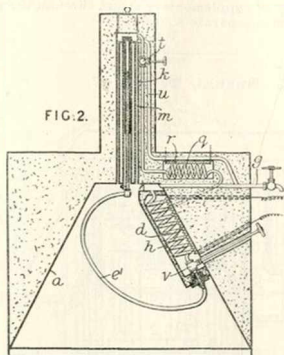
1552. **Brougham, F. J.**, [Kirkpatrick, H. T. E.]. Jan. 19.

*Feed-water, heating.*—A number of compartments *c* are arranged underneath the main water-reservoir *b* in the tender of a locomotive.

In each of these is a series of steam-heated tubes *f* comprising two rows one above the other and secured at their front ends to headers



## 2873. Bell, G. G. Feb. 3.



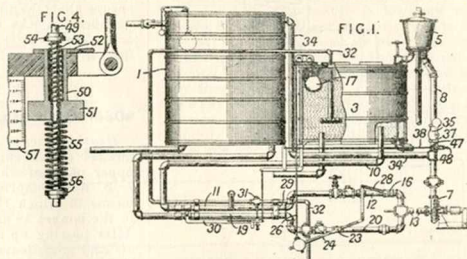
*Heating water.*—Relates to the heating of water from the top downwards, and consists in means whereby the heating-effect is transferred to a lower layer of water when that immediately above is heated to the required degree. In the apparatus shown in Fig. 2, the water to be heated in the coil *d* by the electric or other heater *h* enters by a flexible tube *e'*, the free end of which is borne by a float *m* extending up a chamber *k* formed in the top of the tank *a*.

Means may be provided for adjusting the relative positions of the end of the tube and the float. If boiling water is required at the draw-off *g*, the upper layers of water are heated in circulating through the coil *d* until steam is produced which, collecting in the extension *k*, causes the float to be lowered and thus causes the free end of the tube *e'* to pass into a lower stratum, which passes to the heater. This operation is repeated until the whole is at boiling point or until some water is drawn off, cold water entering at the bottom to take its place in the tank. A tube *u* ensures that the steam in the chamber *k* passes away with the water drawn off. If it is desired that water of a lower temperature be drawn off, a subsidiary circuit is employed in which some of the water already heated in the coil *d* passes through a second coil *g* heated by an electric or other heater *r* and is delivered at the top of the extension *k*. If steam is produced during the second heating, the float drops as before, and the tube *e'* draws from a lower and cooler layer of water in the tank *a* as before. Cocks *t*, *v* regulate the circulation through the two circuits and hence the temperature of the water in the tank. A second supply of hot water may be obtained by circulation through a coil immersed in the water in the tank *a* and thus heated indirectly. In a modified apparatus, the lower end of the float bears an electrically heated plate, which is thus lowered in the tank on the production of steam. The whole apparatus in all the modifications is fitted with a non-conducting casing which may be thinner near the bottom, and the tank itself may be of any shape.

## 3441. Caps, J. E., and Cartwright, C. A. Feb. 10.

*Heating water; water supply and delivery.*—

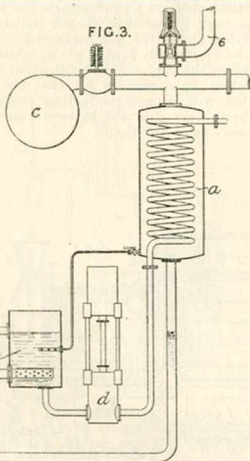
In an installation for supplying hot water at an adjustable temperature maintained automatically, water from a hot-water tank is circulated through a device for heating by exhaust steam, and when it reaches the required temperature is diverted to a cold-water tank from which the hot-water tank is supplied. Means are also provided for regulating the supply of water and an extra supply of live steam for heating. Water from a tank 3 is circulated by a pump 7 through pipes 10, 11, 12, 13, 8 and a device 5 heated by exhaust steam. When the temperature of the water has been raised sufficiently, the expansion of the pipe 11 actuates a lever 30 and thus operates a valve 35 in the pipe 8. The valve 35 is actuated by a weighted lever 37, the end of which engages with a slotted link 38. The length of the slot can be adjusted



by screws 47, 48, and the temperature at which the valve is operated thus regulated. The lever 37 may be rigidly attached to the valve 35, or may be actuated by means of a projection engaging with a recess in the valve spindle so that the valve is suddenly opened and closed. When the valve 35 is closed, part of the water still passes through an opening in it to the heater 5 and tank 3, but the greater part passes by a pipe 34 to a cold-water tank 1. When the

water-level in the tank 3 falls, a float 17 therein closes a valve 16 in the pipe 12 and opens a valve 23 in a pipe 20 by which water can pass from the tank 1 to the pump 7. On its way, the water passes through a pipe 19, which carries the fulcrum of the lever 30 and is secured to the pipe 11 at 29. If the heating-device 5 is not sufficient to maintain the required temperature, the lever 30 opens a valve 31 admitting live steam to the tank 3 through a pipe 32. The connexion of the lever 30 with the stem 49 of the valve 31 is shown in Fig. 4. The stem 49 passes through a block 51 secured to the lever by a hollow-screwed stem 50 and lock-nut 52, and springs 53, 55 press against the block 51 and caps 54, 56 in the stem 49. A projection 57 bearing a scale of temperatures is attached to the lever 30 close to the block 51, and by adjusting the block 51, the valve 31 is caused to open at the required temperature.

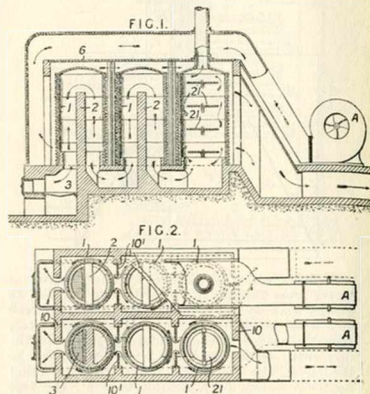
3499. **Morison, D. B.** Feb. 12. [*Cognate Applications, 9754/12 and 15,436/12.*]



*Feed-water, heating.*—A pump *d* delivers through a heater *a* to the boiler, drawing its supply from a secondary heater *b*, heated by the excess steam that passes over when a pre-determined pressure is reached in the primary heater. If the water in the secondary heater has attained a maximum temperature, the excess steam passes to a condenser *c* of the atmosphere. If the normal supply of exhaust steam is insufficient to raise the temperature of the feed-water to the desired limit in the

primary heater, a thermal regulator or steam-pressure regulator automatically may admit a supply of supplementary steam through the pipe 6 from a separate source.

4012. **Suzuki, T.** Feb. 17.



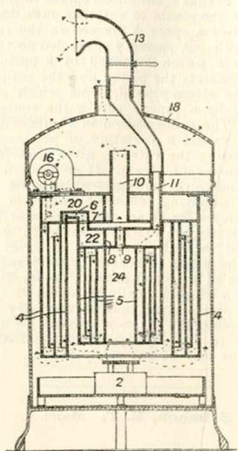
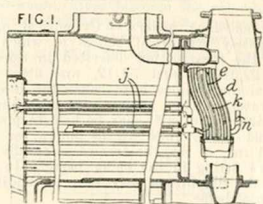
*Heating air.*—Combustion products from the grate 3 pass through flues 1 externally corrugated, being directed by baffles 2, 21. Air to be heated is driven by the fan *A* through an outer conduit and the interspace between the flues 1 and the casing 6. Projecting walls 10, 10' ensure that the air envelops the flues. In one modification, the baffles 2 are hollow and also act as heaters for the air, and in another the flues are arranged horizontally.

4036. **Behrsin, E.** Feb. 17.

*Heating air.*—An air-heater consists of a number of concentric hollow cylinders 4, 5, the upper parts of which are divided by partitions 7, 8, and comprises a fan 16 or the like by means of which the air and combustion gases in the bonnet 18 are impelled into the space 20. After passing up and down the cylinder 4, the air and gases leave it by a passage 6 and enter the chamber 22 at the upper end of the cylinder 5. They then take a tortuous path up and down and round the cylinder 5 and leave the apparatus by a pipe 11 and hood 13. The apparatus as shown is heated by a spirit or gas burner 2, the combustion gases from which pass through flues 24, 9, 10 to the upper part of the apparatus, but it may be heated by other means such as exhaust &c. steam.

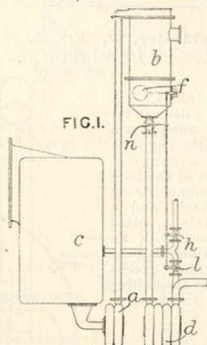
(For Figure see next page.)

4036.

4129. **Caille, C.** April 1, 1911, [Convention date].

Feed-water, heating.—Tubes are arranged

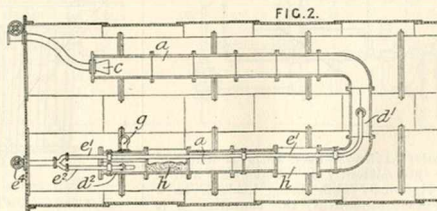
concentricly within the flue-tubes of a locomotive or like boiler to conduct hot gases to a steam-superheater, or feed-water heater in the smoke-box. Tubes *j* conduct hot gases to a tubulous superheater *e* enclosed by a casing *d*. The gases are deflected by a baffle *k*, and their outlet is regulated by a damper *n*. The tubes *j* may extend into the fire-box, and may be formed with trumpet-shaped mouths and bent upwards towards the top of the fire-box.

4547. **Morison, D. E.** Feb. 23.

Feed-water, heating.—The condensate from a condenser *c* is pumped by the rotary pump *a* to a heater *b*, and thence forced by the pump *d* to the boilers. A float *f* in the heater actuates a valve *h* admitting supplementary feed when the level in the heater is low and a second valve *l* allowing the water to circulate through a part of the condenser or other cooling-device when the level is higher than normal. The second valve may be spring-loaded and actuated by the rise in pressure due to a reduction in the supply of water entering the boiler. A valve *n* may be employed, so that when the level falls unduly, a part of the supply to the main pump *d* is cut off.

4727. **Green, J. H.** Feb. 26.

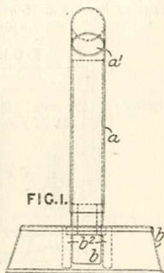
Feed-water, heating.—A U-shaped trough *a* is supported in the steam space of a Cornish or like boiler by rods resting on the flues. The trough is inclined from the end at which the water enters at *c* to the well or recess *d*<sup>2</sup> at the other end from which the water overflows through the pipe *g* to the level of the water



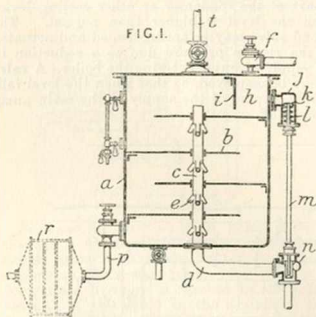
in the boiler. A second recess  $d^1$  is fitted at the bend. Filters  $h, h$  are fitted as shown. The sediment recesses  $d^1, d^2$  are cleared by the pressure of steam driving their contents through a pipe  $e^1, e^2$  having branches dipping into the recesses and controlled by a valve  $e^4$ . A device for ensuring automatic clearing is described by means of which the opening of the furnace door operates, through a pawl, a ratchet-wheel upon which is a projection arranged to strike the rod of a valve in the sediment discharge pipe once in each revolution of the ratchet-wheel.

5077. Tyldesley, W. Feb. 29. *No Patent granted (Sealing fee not paid).*

*Washing-boilers.* — A circulating - device for coppers &c. comprises a base  $b$  with an inlet for water, a flange  $b^2$  on each side of the inlet and extending from front to back, and a telescopic tube  $a$ , fitted in this base, with an outlet  $a^1$ , which is bent over at its upper end so as to deliver the boiling liquid over the contents of the pan.



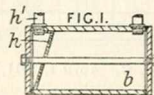
5246. Brázda, T., Schückher, A., and Richter, E. March 2, 1911, [Convention date].



*Feed-water, heating.*—Feed-water is led to a container intermittently or continuously and is agitated vigorously while being heated. In a direct-contact apparatus, the container  $a$  is

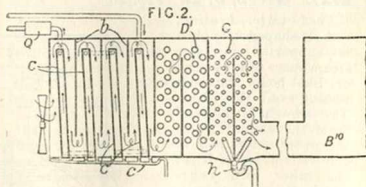
divided by baffles  $b$  to compel the water entering at  $f$  to take a circuitous course to the exit  $p$ . To allow the steam to enter in puffs, the water first enters a space  $h$  formed in the container by a wall  $i$ . A casing  $j$  connected to the space contains a piston  $k$  loaded by a spring  $l$ . A rod  $m$  connects the piston and the cut-off valve  $n$  of the steam-pipe  $d$ , from which steam is supplied by a pipe  $c$  within the container by jets  $e$ . The condensation of steam within the space  $h$  causes a variation of pressure which, by operating the valve  $n$ , gives rises to a pulsating inflow of steam. If desired, a similar piston-and-valve arrangement may be used to cause a pulsating inflow of water; or coupled rotary valves for steam and water may be used. Modifications are described in which the water is passed through containers in series and in which the water is heated by a steam-pipe in the form of a looped stirrer. Separated gases are blown off periodically by a pipe  $t$ . If more mud is precipitated than is necessary for use in the boiler, the excess is removed by a filter  $r$  inserted in the pipe  $p$  when required. The apparatus may be externally heated.

5400. Stimson, E. F. March 4.



*Kitchen-range boilers.* — Cylindrical or approximately cylindrical boilers  $b$ , which may be of the construction described in Specifications 29,011/11 and 52/12, are fitted with internal diaphragms  $h$  to cause the incoming cold water to have a circuitous path through the boiler. The baffle may be held in place by the cold-water inlet  $h^1$ , as shown, or by a central rod, or may be formed integrally with a sleeve fitting in the boiler barrel. In some cases, the diaphragm may bear an additional horizontal baffle.

5706. Haddan, R., [General Dehydrator Co.]. March 6.



*Heating air.*—To produce dry warm air for



drying fruits &c., the air which is to be supplied to the storage &c. compartment B<sup>10</sup> is first passed over the surface of narrow cooling-chambers or plates containing cold water, whereby moisture is condensed and deposited, and then over heating-pipes D<sup>1</sup>, G. The pipes

D<sup>1</sup> are heated by the waste gases from the boiler furnace, and the pipes G are heated by exhaust steam from a steam-engine, a fan ensuring the passage of the gases, and a trap h providing for the removal of water of condensation from the steam-pipes.

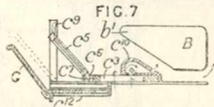
5913. **Prior, J. D.** March 9.

*Water-tube boilers.*—A boiler for a domestic fire-grate comprises end boxes *b* connected by one or more series of flattened tubes *a* placed louver-fashion. The tubes may rise slightly from inlet header to outlet header; and for this purpose a detachable shoe may be affixed to the outlet header.

FIG. 5.



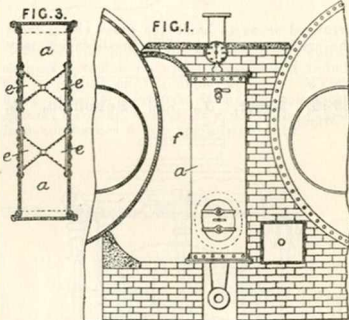
5937. **Morrison, W.** March 9.



*Kitchen-range boilers B* have a small forward end *b'* overhanging the fire to facilitate the heating of the water.

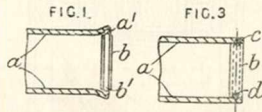
6136. **Green, W.** March 12.

*Feed-water, heating.*—A chamber *a* for heating feed-water, fitted between the side flues *f* of adjacent Lancashire and like boilers, has double conical depressions *e*, or other internal transverse passages to increase the heating-surface.



6148. **Stimson, E. F.** March 12.

*Kitchen-range boilers.*—The ends *b* of a cylindrical or approximately cylindrical boiler are fixed in position by first expanding the shell *a*, as shown in Fig. 1, and then forcing the edges inwards so that the groove *a'* embraces the circumferential ridge *b'* on the end *b*. In a modification shown in Fig. 3, the locking-ring is made after placing the end in position by the interposition of molten lead, which fills the grooves *c, d* formed in the shell *a* and end *b* respectively.



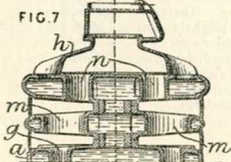
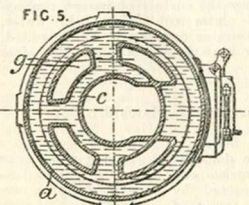
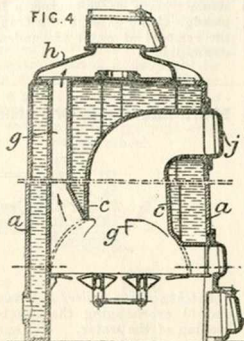
6266. **Gaillard, C. M.** March 13.

*Vertical boilers.*—The water jacket extends to the lower end of the boiler *a* and surrounds

the furnace and ash-pit, and the upper end of the fuel magazine enclosed within the walls *c* communicates with an aperture *j* in the wall of the boiler. The flue gases pass through

passages *g* arranged round the grate to a smoke-box *h*. In a modification, Fig. 7, water-holding

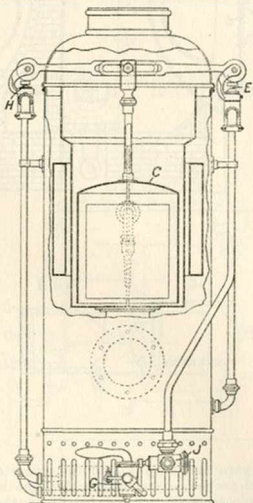
elements are added to the upper part of the boiler, and the flue spaces *m*, *n* in them are



arranged so as to baffle the gases rising from the smoke passages *g*. This modification may

be used for generating low-pressure steam for heating purposes.

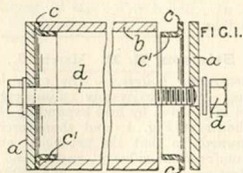
6996. **Stott, J., and Schofield, L.**  
March 21.



Water supply and delivery.—In heaters for

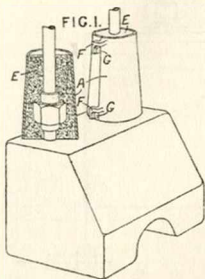
delivering boiling water, in which the cold-water inlet is regulated by means of a bell float C actuated by steam collected thereunder, when the main interconnected gas and water cocks G, J are short, the water is kept at boiling-point by the actuation by the float C of a valve H upon a by-pass gas or other heating-medium service.

7557. **Stimson, E. F.** March 28.



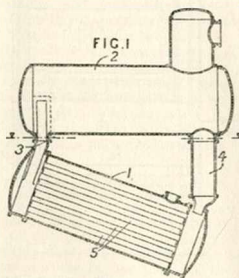
*Kitchen-range boilers.*—Packing-material for use in making joints in range boilers is composed of soft metal having a low melting-point as compared with that of the material of which the boiler is constructed. In the example shown, a cylindrical boiler *b*, substantially as described in Specification 29,011/11, has end plates *a* held together by a bolt and nut *d*, the packing *c* extending partly into the boiler at *c'*.

8211. **Hail, J. J., and Worswick, J.**  
 April 4.



*Block-form boilers.*—Pipe unions or fittings such as safety-valves used on domestic or other water-circulating boilers are protected by a sleeve A of cast iron, earthenware, or other refractory material, packed with mortar E or other suitable material. The sleeve may be of circular or other cross-section and of tapering or cylindrical form. Instead of being in one piece, it may be in two parts to facilitate application to existing unions or fittings. The parts may have engaging hooks F and projections G or may be held together by a separate ring in two parts, surrounding the sleeve and coupled by suitable projections.

8249. **Hallström, F., and Brandt, O. F.**  
 July 21, 1911, [Convention date].



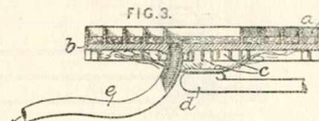
*Heating liquids.*—An apparatus for evaporating liquids consists of superposed chambers

1, 2, the lower chamber 1 having inclined passages 5, through which the liquids circulate, the passages being heated or cooled externally, and communicating at either end, as by pipes 3, 4, with the upper chamber 2. A number of such units may be arranged in a single casing.

The Specification as open to inspection under Section 91 (3) (a) comprises also the use of the apparatus for heating liquids for purposes other than evaporation; this subject-matter does not appear in the Specification as accepted.

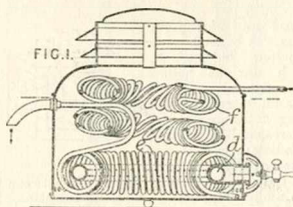
Reference has been directed by the Comptroller to Specification 24,829/94, [Class 32, Distilling &c.].

8587. **Roth, E.** Jan. 4, [Convention date].



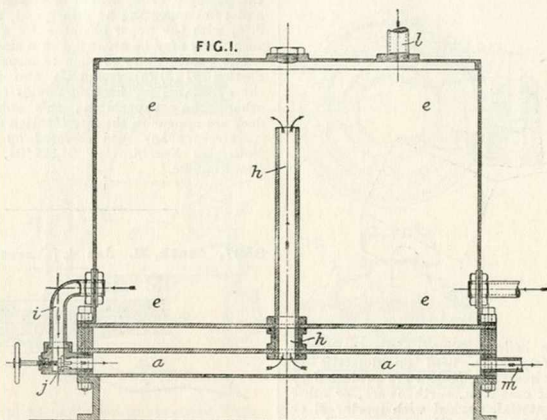
*Geysers.*—A plate *b* has a substantially spiral channel *a* cut in its upper surface and radial ribs *c* formed on the under surface. Water flows preferably inwards from the outermost channel escaping, heated, at *e*, while the flames from the burner *d* pass radially outward.

9012. **Schaefer, F.** April 16.



*Water-tube boilers.*—Coils of tubing are heated locally at one point only of the various turns to secure rapid circulation. In the example shown, a circular burner *d* is surrounded by a coil *e* and heats the various convolutions at one point only by jets on the inner side of the burner. Additional coils *f* may also be heated similarly by the hot gases rising through the centre.

9114. **Hansom, O.** April 18.

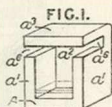


*Heating water.*—An upper closed tank *e* forms a hot-water reservoir and communicates by conduits *h*, *i* with a lower smaller closed vessel *a*, a valve *j* being fitted on the conduit *i*. Heat is applied to the lower vessel and hot

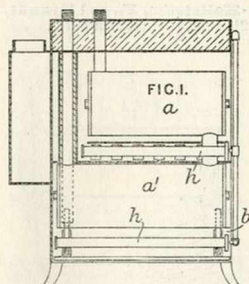
water circulates through the pipes *h*, *i* and also through the pipe *l* to the domestic hot-water service. The hottest water can be drawn off when required by closing the valve *i* and opening a tap upon the pipe *m*.

9367. **Rutter, J. M.** April 20. [Addition to 3582/09.]

*Block and slab form boilers.*—A boiler having a hollow bottom *A*, with upright hollow side and back parts *a*<sup>1</sup>, *a*<sup>2</sup>, and intercommunicating water spaces, has a corresponding part *a*<sup>3</sup> extending over the fire connected with the back part only, flue spaces *a*<sup>6</sup> being left between the roof and side parts. In a modification, the part *a*<sup>3</sup> slopes towards the back.



beneath each chamber. The whole is arranged in a casing *b* which may be heat-insulated.



9538. **Stimson, E. F.** April 22.

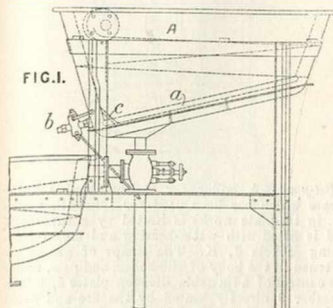
*Block-form boilers.*—A "circulator" for heating water, without or in addition to the use of the kitchen fire, comprises two or more water chambers *a*, *a*<sup>1</sup> preferably constructed according to Specifications 29,011/11 and 52/12, in series, one or more burners *h* being arranged

9586. **Fairweather, H. G. C.**, [Deutsche Sprengstoff Akt.-Ges.]. April 23.

*Boiling-pans and the like.*—Apparatus for

melting nitro-compounds &c. comprises a vessel A steam-jacketed and so shaped that the substance must always rest in contact with the heated walls and provided with a channel *a*

end passing through or under the back and drawing water from the top water space.

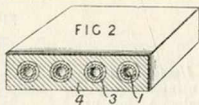


by way of which the liquefied product passes to the draw-off cock, a system of cross-tubes *c* through which the steam may pass being interposed to prevent the passage of solid portions to the steam-jacketed cock *b*.

9745. **Imray, O.**, [Luckenbach Inventions Development Co.]. April 24.

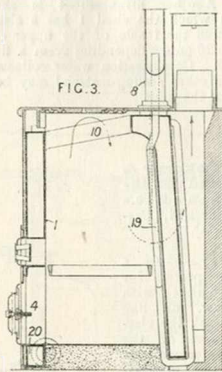
*Heating liquids and gases.*—An apparatus or structure for heating or superheating liquids or gases, and which may form the enclosing wall, "dome," or

bridge wall of a furnace, comprises a metal chamber, channel, or tube 1 of any form having a metal body 4 cast about and spaced out from it for absorbing and transmitting heat, and a pulverized non-fusible refractory substance in the space 3 between the chamber &c. and the cast metal body to allow for expansion &c. under heat. A suitable composition is stated to be composed of blast-furnace clay, two parts, and of graphite, one part, with cotton-seed oil as a mixing medium. This is put on the tubes &c. while in a plastic state, baked, and the metal body cast on to it, the heat reducing it to a pulverized condition.



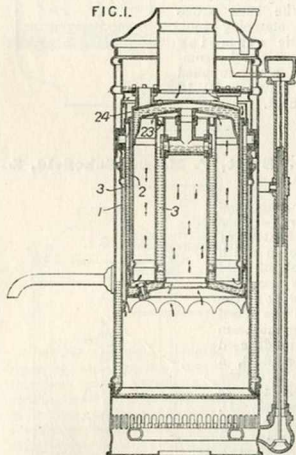
9756. **Courtot, L.** April 24.

*Internally-fired boilers.*—In a cooking-stove, a water jacket 1 in the shape of a bell has an inclined top, and an opening 10 therein for the escape of combustion gases, the outlet 8 for the hot water being situated at the highest point of the inclined top. The two sides have a communicating passage 20 passing under the ash door 4. A device for assisting circulation may be fitted comprising a tube 19 opening into the outflow pipe, the other



10,236. **Barralet, T. E., and Parkinson Stove Co.** April 30.

FIG. 1.



*Internally-fired boilers.*—Separable or detachable means are provided for sealing the joints of water chambers in geysers or like water-heaters. For example, the annular water chambers 3, 3 in the geyser shown

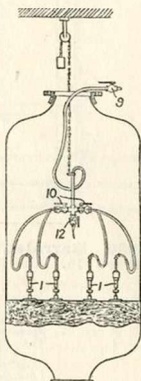
FIG. 8.



in Fig. 1 are closed by covers 23, 24 of U-section with spring sides adapted to hold the covers in place by friction. Another arrangement is shown in Fig. 8, in which the shell 1 has a channel 25 formed round the inside of the upper end into which a lip 26 enters depending from a flange on the wall 2. Condensation water collects in the channel, or other sealing-material may be placed there to seal the joint.

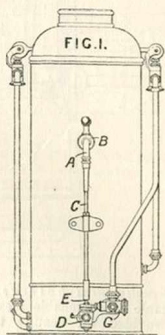
**10,548. Pokorny & Wittekind Maschinenbau - Akt. - Ges.** March 14, [Convention date].

*Digesters.*—In a stamping-in process for charging boilers with wood, straw, or like elastic material, the elastic after-effect of the material is overcome by stamping the material in, with such rapid blows, that the material has not sufficient time to expand again and to follow the back stroke of the stamping-tool. Pneumatic stamping tools 1, driven by compressed air supplied through valves 9, 10, 12 may be used.

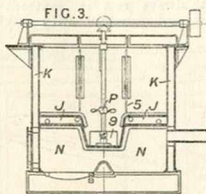


**10,955. Stott, V. H., and Schofield, L.** May 8.

*Water supply and delivery.*—In a water-heater of the type in which the inlet of cold water is permitted only when the water in the vessel is boiling, the steam thus produced raising a float, a stop tap B on the outflow A, the gas or steam valve D, and the main water inlet valve G are interconnected. Thus, on closing the outflow valve the heating-medium and the main cold water supply are cut off. As shown, the valves B and D are actuated by a common spindle C, the valve G being controlled from the same spindle by a cam.



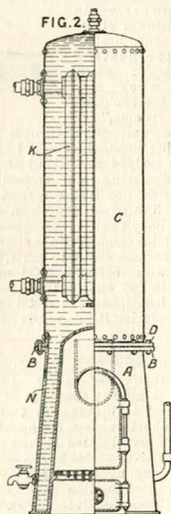
**11,023. Young, D.** May 9.



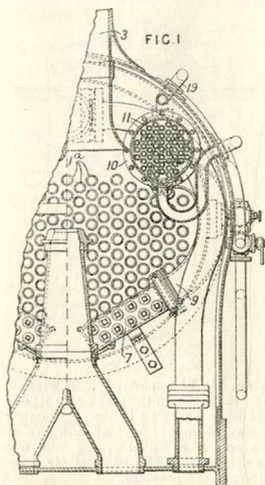
*Set-pans.*—A boiler for melting and refining grease which has been used for lubricating rolls &c. in tin-plate works is heated by a furnace N and is fitted with water-heating and steam-generating jackets J, K. The lumps of grease are softened in the body of the boiler, and pass, under the control of adjustable division plates 5, into a chamber 9 directly heated by the fire and fitted with mixing-blades P. The heavier impurities settle out and are expelled through a door, and the grease flows in regulated quantity through a perforated plate into a pipe leading to the strainer. This plate may be cleaned by a blast of steam derived from the heating-jacket.

**11,113. Jones, W., and Chasser, G.** May 10.

*Heating water.*—An internally-fired boiler A for use with solid fuel having a crownless external shell N, and a storage vessel C entirely open at its base, are bolted together to form a complete closed water heating and storing apparatus, a flange joint A, B being provided of the full diameter of the external shell for ease in disconnecting. A secondary heater K may be fitted in the storage vessel for a second circulation of hot water.



11,216. Margery, C. May 11.



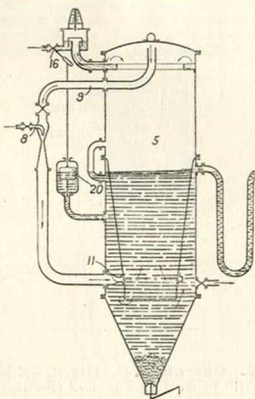
*Feed-water, heating.*—The furnace gases of a locomotive boiler as they issue from certain of the tubes 1<sup>a</sup> are trapped in a chamber 7 which has spigots entering the tubes, and thence are conducted by a duct 9 to a header at one end of a drum 10 and traverse tubes 11 to a similar header at the other end, finally passing to an outlet at the base of the chimney 3. The feed-water from the injector passes into the lower part of the drum 10 and thence by way of the pipe 19 to the usual check valve on the boiler. Two such drums are usually fitted in the smokebox.

11,713. Soc. d'Exploitation de Procédés Evaporatoires Système Prache et Bouillon. May 29, 1911, [Convention date].

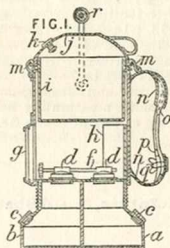
*Heating liquids.*—Liquids are boiled by the injection of vapour or steam through a ring of jets 11, substantially all the vapour from the liquid thus boiled being withdrawn from the vessel 5 through the pipe 9 and returned into the mass of the liquid, mixed only with the vapour injected through the jet 8. In place of an injector, mechanical means may be used. A float 20 controls the inlet of liquid by the cock 16.

(For Figure see next column.)

11,713.



12,016. Gillett, J. S. May 21.

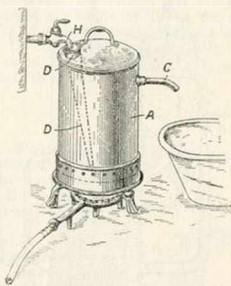


*Portable and small liquid-heaters.*—A cooking, warming, and lighting lamp or stove for use by travellers, picnic parties, scouts, &c. comprises a cooking-vessel *i*, which is secured by clips &c. *m* in the lamp casing and provided with a screwed lid *j* which serves as a drinking cup. In the cup *j*, a safety-valve *k* is provided, and a bail handle *r* secured to the vessel *i* and passing through slots in the casing enables the device to be carried.

12,256. Hanwell, H. W. May 23.

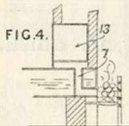
*Portable liquid-heaters; water delivery.*—A vessel *A* for heating water is provided with a lid bearing a conduit *D* extending nearly to the bottom, and a

delivery spout C. Heated water is discharged by admitting cold water from the tap H.

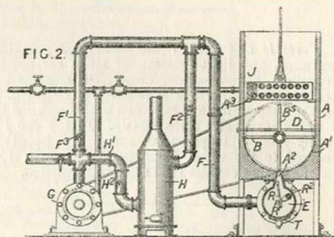


**12,289. Currah, J. C.** May 24. [Addition to 27,917/10.] No Patent granted (Sealing fee not paid).

*Boiling-pans.*—The hot gases, after passing through the flues 7 in or around a boiling-pan constructed as described in the parent Specification, heat ovens 13 placed above or at the side of the boiling-pan. Further, a tight-fitting lid may be fixed over the pan, and steam generated therein for various domestic uses, heating hollow plates or tubes for drying clothes or towels &c.

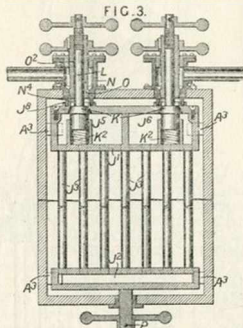


**12,599. McIntyre, J., and Shetley, W. de.** May 28.



*Heating liquids and gases.*—In an apparatus for drying milk, bananas, eggs, pumpkins, potatoes, &c.,

a hot-air blast is derived from a plant comprising a blower G, Fig. 2, and a heater H, together with pipes H', F', F'', and a by-pass pipe F''', the temperature being regulated by manipulating valves H', F',



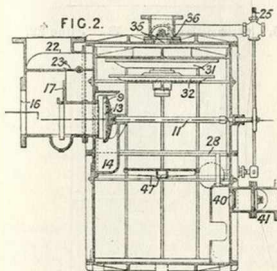
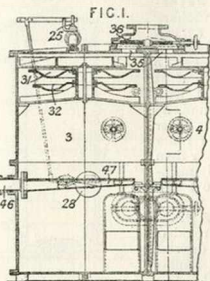
in the pipes H', F' respectively. A wiper or valve R, loosely mounted on the crank arm R' of a rocking shaft R, is provided in the air chamber E', so that it may be moved up and down in order to clear the port A' of any adhering solid matter, or may be arranged to throttle the air supply and thus increase its pressure. A steam heater for liquids which is bodily removable from the container is shown in plan in Fig. 3 together with the arrangements for admitting and exhausting steam after it has been lowered on to the supporting brackets A' in the pan &c. It consists of tubes J' with headers J', J'', of which one J' is divided into supply and exhaust compartments J', J''. A tight joint with the steam-boxes N is made by means of annular flanges N' and grooves J', which are made to engage by pushing the exchanger bodily forward by a screw P. The valves K, which are normally closed by springs K', are then opened by screwing the rods L downwards; and the valves O are opened by screwing their stems O' upwards.

**13,145. Elliott, W. S.** June 4.

*Feed-water, heating.*—A duplex heater comprises similar chambers 3, 4, in each of which is a series of trays 31, 32 over which water to be heated flows, the supply being controlled by floats 28 operating valves 25. Heated water leaves the chambers at 40, the two apertures being closable by a sliding valve 41; a similar valve 36 controls the steam-outlet ports 35. Steam-admission is permitted by valves 9, each having a face 13 corrugated so as to act as a steam-separator, oil and other entrained matter falling into pockets 14. A baffie-

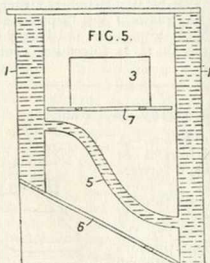


plate 17 may also be employed, the face of which may also be ribbed to act as a separator. The main steam inlet is at 16 and a valve 23 by-passes any



excess. If the apparatus is used in connexion with a steam-heating system, the passage 22 opened by this valve connects with the system. A scum-removing tray 47 and pipe 46 are fitted.

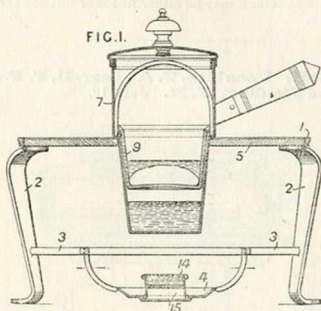
**13,147. Chavée, C.** June 4. *No Patent granted (Sealing fee not paid).*



*Internally-fired boilers.*—The fire-place of a

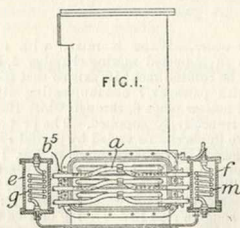
kitchen range consists of a double-walled casing forming a boiler 1, in the sides of which are iron panels 3. These are in contact with the fire, and form parts of the sides of the adjacent ovens, and are thus heated by them. A water-circulating tube 5 is fitted, and also two grates 6, 7.

**13,748. Suckling, J.** June 12.



*Portable and small liquid-heaters.*—A small stand is provided with devices which adapt it for various uses, including the boiling of water. The stand consists of a frame 1 on legs 2 connected by brackets 3 carrying a central tray 4 for supporting a burner or lamp. An aluminium plate 5 with a central aperture adapts the stand for boiling water &c. A special vessel or saucepan 7 is provided.

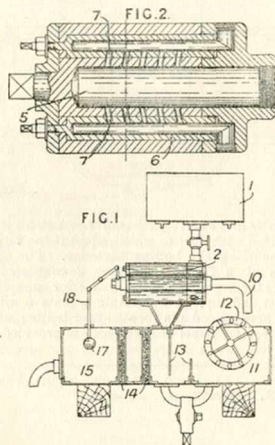
**14,332. Davie, J.** June 19.



*Feed-water, heating.*—The admission and emission ends of the coils in a liquid heater or evaporator pass out of the casing at a joint, the opposing faces at such a joint being formed with semicircular openings, which may be adapted as stuffing-boxes. Registering grooves are formed upon the faces to hold the packing &c. In the apparatus shown the

ends of the evaporator coils *a* pass out at the junction of the door and the casing, stuffing-boxes *b* being provided. Low-pressure steam for heating enters the casing *e* and is superheated by a live-steam or other heating-coil *g*. After passing through the coils *a*, the steam is discharged into a receiver *f*, through which a coil *m* may extend, conveying water or liquid to the evaporator for preliminary heating. Apparatus of this type is stated to be applicable to heating feed-water. The heating-medium may be either inside or outside the tubes.

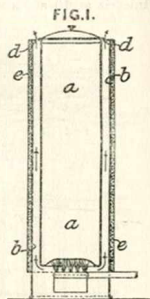
**14,351. Venables, T. A., Carroll, F. F., and Fielding, W. H.** June 19.



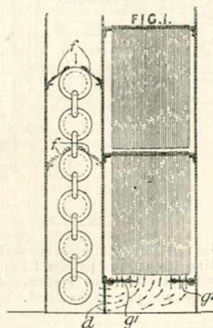
*Heating water.*—Water is mixed with reagent and steam in a ported mixing-chamber 5, Fig. 2, which can be rotated about its axis so that its ports coincide with passages 7 communicating with the interior of hollow plugs 6, through which the three fluids are respectively supplied. The proportions of the three fluids can be varied by partial rotation of the plugs. Apparatus as shown in Fig. 1 comprises a reagent tank 1, a mixer 2, and a settling-tank 11. The water passes from the mixer 2, and a settling-tank 11. The water passes from the mixer 2 through a pipe 10 delivering on to a water-wheel 12. The settling-tank is provided with baffles 13, filters 14, and a float 17 connected by levers 18 to the end of the chamber 5, so that the latter is rotated to shut off the supply of the fluids when sufficient water has collected in the storage compartment 15.

**14,535. Ash, A. E.** June 21.

*Set-pans.*—A household water-heating stationary apparatus comprises a vessel *a* with a jacket *b* having holes *d* at the top and with lagging *e* round the outside. The lower edge of the inner vessel is lower than the part immediately above the burner, to form a drip edge. A draw-off tap is provided, and also, if desired, a ball-cock supply arrangement.



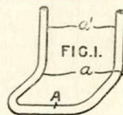
**14,606. Openshaw, J. R.** June 22.



*Heating air.*—In each air-heating chamber of a drying-apparatus of the kind comprising a number of drying and air-heating chambers arranged alternately in series, plates *f* are disposed above the uppermost gilled steam-pipes and it may be above others, whereby the air is forced into contact with the pipes.

**14,800. Brierley, R.** June 25.

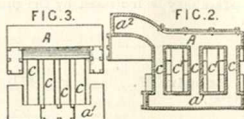
*Water-tube boilers.*—A single water-tube *A* of U-shape is bent forward at *a* so that its lower end may project through the space leading from the flue to the fire, the legs or upright portions *a'* extending partly up the flue at the back of the range.



1912]

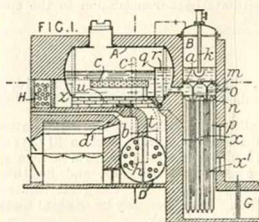
CLASS 64(i), HEATING LIQUIDS &c.

15,193. **Rutter, J. M.** June 29.



*Boilers.*—Two channel-shaped box parts A, *a'* are united by a stack of tubes c, c'. One of the box parts may be extended beyond the other as at *a'*. The boiler may be mounted with the flue passage vertical.

15,481. **Romanet, E. E.** July 2.

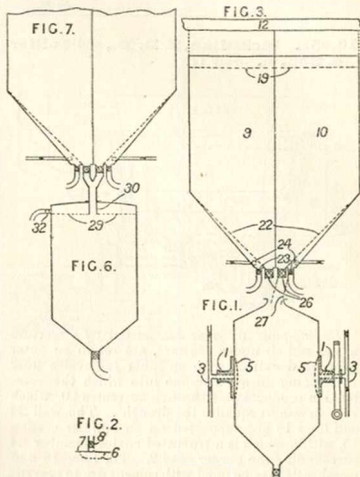


*Feed-water, heating.*—In a composite boiler, feed-water enters the system by a pipe *k* projecting into a heater B comprising open tubes *o* and closed tubes *p* carried by partitions *m, n* between which is a conduit *q* leading to the main boiler A. Baffles *x, x'* cause the furnace gases to take a circuitous course to the chimney G.

15,779. **Rayner, G. H.,** [Raitt, W.], July 5.

*Boiling-pans; digesters.*—In a process for extracting cellulose or paper pulp from fibrous vegetable materials, such as bamboo, wood, grass, straw, reeds, jute, &c., the non-cellulose parts are removed in separate groups, by a process of fractional digestion. The apparatus used comprises auxiliary digesters 9, 10 having perforated false bottoms 22, perforated screen doors or lids 19, means such as steam-pipes 24 for heating, valves 23 for running-off the liquid, and valves 26 for the removal of the material to the rotary digester through a movable funnel 27. The raw material, chipped, crushed, or otherwise reduced, is delivered to the auxiliaries by overhead troughs 12. Light dirt and scum are carried away by sluice boxes just above the doors 19. The water-soluble substances and the pectose-substances are removed in the auxiliaries, which are made sufficiently large to fill the rotary digester with the shrunk material. This material, after washing with the washings

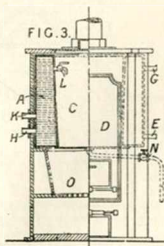
from a previous lignin digestion, is flushed into the rotary digester by excess of the stronger caustic soda, with the object of removing the lignin. The excess of liquid is allowed to run



away through branches 3 in the steam-pipes 1, or through a cock 8 in the door plate 7, Fig. 2, screens 5, 6 preventing the escape of the fibre or material. Fig. 6 shows a stationary closed digester having a fixed connexion to the auxiliaries, an upper compartment, formed by a screen plate 29 and a pipe 30, enabling the excess liquor to be run off through the pipe 32. Two or more auxiliaries built together or separate may be provided for each digester, and the discharge valves of the rotary digester may occupy any convenient position.

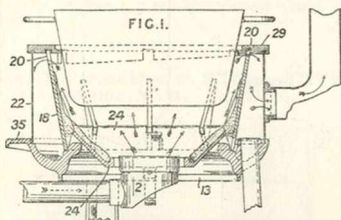
15,983. **Rees, A. P., and Bush, A. W.** July 8.

*Washing-boilers; heating water.*—A jacket A surrounding the wash-boiler C is connected by circulating-pipes K, H with a kitchen-range boiler. The wash-boiler may be heated by a fire in the furnace O and can be drained by a stop-cock N. A valve L allows of filling the pan from the surrounding jacket. The jacket is narrowed at the



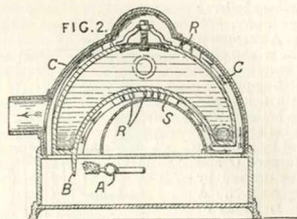
back at the place where the flue from the fire O goes up within the casing D. Connexions G, E serve respectively to supply hot water to a bath &c. and to receive cold water from a supply tank.

**16,651. McMillan, T. D. D., and Collier & Son, L.** July 17.



*Boiling-pans* for sugar &c., heated by a mixture of gas and air under pressure, are set in an outer cylindrical wall 22 with an inner removable liner 18 forming an annular flue into which the combustion products pass through apertures 20, which vary in size to equalize the draught. The wall 22 and liner 18 are supported on an annular casting 13, within which is a truncated conical member 24 surrounding the burner head 2. The liner 18 and member 24 may be lined with cement &c. to prevent radiation. According to the Provisional Specification, a refractory lining may be provided within the wall 22, and a fire-clay or other jacket may be provided on the liner 18. A ring 29 forms the top of the annular flue and may be fitted with loose rings so as to accommodate pans of various sizes. Holes permitting the size of the flame to be viewed may be formed in the wall 22 and the liner 18. A shield 35 for protecting the hand from the heat when manipulating the gas and air valves is provided on the casting 13.

**18,255. Wilson, W. A.** Aug. 8.



*Boilers.*—The products of combustion from an horizontally placed burner A pass over the whole

surface of a saddle-shaped boiler B in one direction, being directed by baffles S and casing C. The heating-surface may be increased by the provision of ribs R.

**18,296. Schulz, F.** Sept. 15, 1911, [Con-  
vention date].

*Boiling-pans.*—A pan primarily for evaporating brine has heating-channels formed in the thickness of the bottom and walls or made by suitably bending the metal of the pan, the channels being closed at their greatest cross-sectional surface to the inside of the pan by a thin strip or strips of metal disposed flush with the interior surface and fixed by sweating &c. to facilitate heat-transmission to the contents of the pan.



**18,686. Richard, M. M.** Aug. 16, 1911,  
[Convention date]. Drawings to Specification.

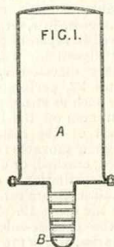
*Internally-fired boilers.*—The Specification as open to inspection under Section 91 (3) (a) describes a boiler of rectangular form with a special grate, a central fuel reservoir, and fire-tubes on each side of the reservoir. The grate bars may be water-tubes. The boiler may be of sheet metal and may be set in brickwork.

**18,834. Lobeck, O.** Aug 16. Drawings to  
Specification.

*Heating liquids.*—Milk, blood serum, hæmatogen, water, &c. may be heated in narrow tubes to which air &c. may be admitted to divide up the liquid.

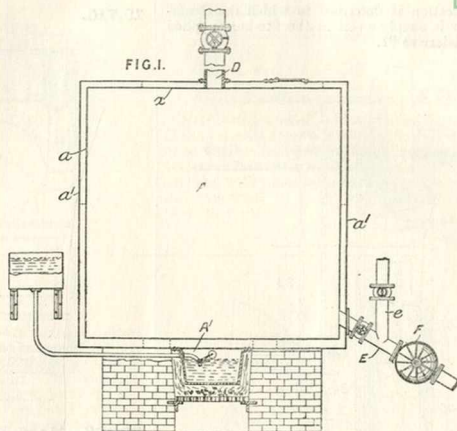
**19,190. Stevenson, A.** Aug. 22.

*Block-form boilers.*—A hot-water storage tank A, which stands upon the stove or fire-place, is provided with a depending part or parts B, which extend into the furnace. The depending portion may have fire tubes extending through it, is preferably extended in plan, and may project beyond the sides of the furnace. Instead of, or in addition to, the depending receptacle, a series of tubes may be fitted to the bottom of the storage tank

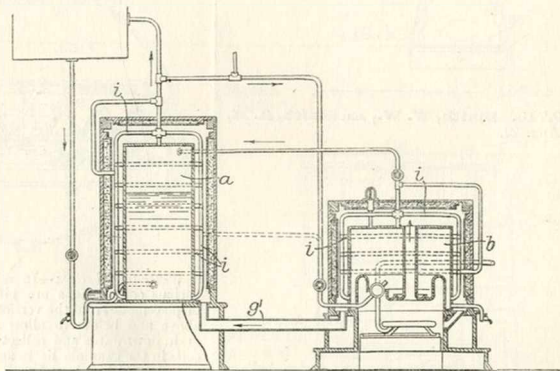


**19,212. Dodds, J.**  
 Aug. 22.

*Heating air.*—Relates to apparatus for heating air for warming and ventilating buildings. A double-walled chamber A is provided with a water tank A' heated from below so as to generate steam, which, passing into the jacket space between the double walls a, a', heats the air in the chamber A. Supply and exit trunks E, D, suitably valved, are provided for the air. A forcing-pan F is shown, but exhaust fans upon the delivery pipe may be used. A branch pipe e on the trunk E enables cold air to pass direct to the building if required.


**19,382. Johnson, E. H.**  
 Aug. 24.

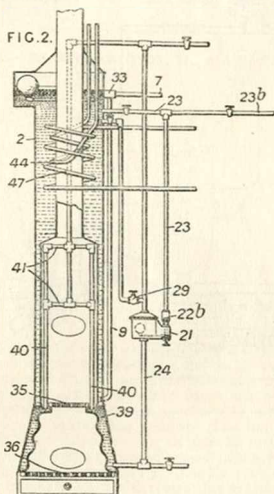
*Heating water.*—A water-heating apparatus, of the type having a flue-jacketed container a and a similarly-jacketed boiler b with a connecting-flue g' between, has hot-water circulation pipes i in each flue-chamber jacket which are stated to assist in the heating operation.


**19,568. Ponninghaus, W. E. D., and Wallace, J. A.** Aug. 27.

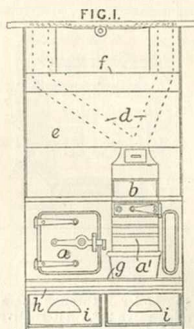
*Internally-fired boilers; heating water.*—An apparatus for supplying hot water and steam comprises a water-heater 2 supplied with water through the tubes 7, 9 under the control of a float-actuated valve 33, and a tubular steam-generator 40, 41 connected to a water jacket 39 and supplied with

water from the boiler 2 through tubes 23, 24 and a float-controlled valve 22<sup>b</sup>. Alternative fire-grates 35, 36 are provided. In case of over-production of steam, a relief valve 29 allows its escape into the water of the boiler. The steam system may be converted into a secondary hot-water system by flooding and supplying with cold water from the auxiliary supply pipe 23<sup>b</sup>. Hot water may also be produced by circulation through the coils 44, 47.

A modification is described in which the steam-generator is simply a coil in the fire-box supplied from a cistern as 21.



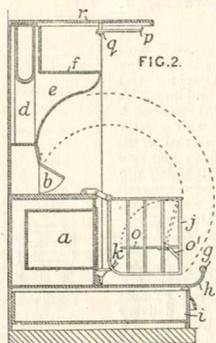
19,710. Smith, W. W., and Smith, A. H.  
Aug. 29.



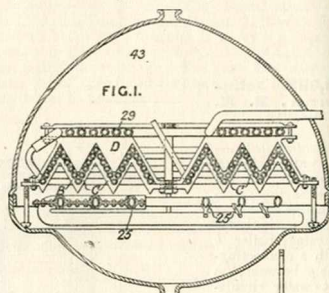
*Block-form boilers.*—A stove comprises a water-heater *e* traversed by two flues *d*, the upper parts of which, after passing beyond the flat top of the boiler, are water-jacketed.

(For Figure 2 see next column.)

19,710.



20,106. Reed, R. F. Sept. 3.

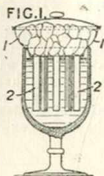


*Water-tube boilers.*—In a coil-tube boiler, the various convolutions are given sufficient lateral displacement from the vertical relative to the coils above and below to allow any condensation to drain downwards and collect on the lowest. The coils in the example lie in annular ridges, and are spaced apart by plates *D* and supporting-bars *B*, *C*. A burner comprises a series of rings *25* spaced so as to avoid the condensation dropping from the lowermost convolution of the various ridges. A secondary water-coil *29* is mounted above the main heater. The whole is enclosed in a suitable casing *43*.

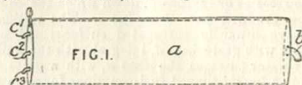
20,350. Leclair, C. C. Sept. 6.

*Small liquid-heaters.*—An appliance for heating beverages consists of a receptacle *1* for containing hot water &c., provided at its base with a

cluster of depending tubes 2 which dip into the liquid. A passage-way fitted with a grating to hold sugar &c. may be formed in the container 1, and a lid and handle may be provided. In a modification, the tubes may be replaced by a depending annular vessel having an air vent at the top or through the container.



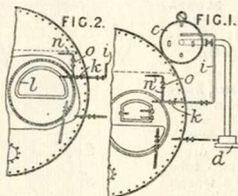
## 20,691. Makin, E. Sept. 11.



*Feed-water, heating.*—Water is supplied to the D-shaped coils described in Specification 28,689/09 or to similar feed-heaters fitted in the flues of a battery of boilers through a reservoir or header *a* supplied with water by a pump through a pipe *b* and connected to each heater through separate pipes *c*, *c*, *c*.

## 20,692. Makin, E. Sept. 11.

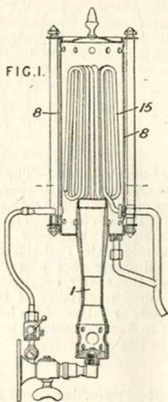
*Feed-water, heating.*—Relates to a coiled water-tube *l* placed in a boiler flue and connected at one end to a pressure header *c* and at the other end to the lower part of the boiler. Specification 28,689/09 is referred to. To allow water to circulate through the coil in a reverse direction when the pump *d* supplying water to the header is not working, the coil is provided with a relief pipe *n*, which places the feed-pipe *i* on the boiler side of the non-return valve *k* in communication through a cock *o* with the upper part of the boiler.



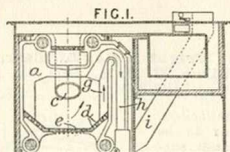
## 21,067. Mercier, E. E. Sept. 16.

*Water-tube boilers.*—Water passes through a coiled tube 15 arranged within a casing 8 in such a way that while permitting the hot gases from the single burner 1 to pass freely, the coil fills the space within the casing as far as possible.

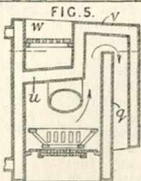
Reference has been directed by the Comptroller to Specifications 16,949/90, 1958/00, and 21,497/05.



## 21,465. Alt, K. Sept. 20. [Addition to 8808/11.]



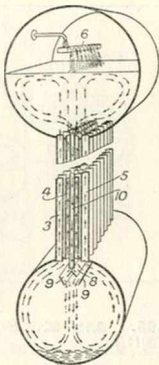
*Internally-fired boilers.*—In cooking and water-heating stoves of the type described in the parent Specification, in which an ordinary grate for cooking purposes and a slow-combustion grate for water-heating are provided, and in which the water inlet is at the bottom of the boiler and the outlet at the top, the combustion products are led upwards and downwards through the water space, and the cross members of the boiler may provide a gradually ascending path for the water.



In the sectional boiler shown in Fig. 1, the sections *g* have recesses or cavities *h*, down which the combustion products pass to a flue *i*. The sections *a, g* have inwardly corrugated surfaces and are provided with grate bars *d*, integral with the walls of the water passages, the bars *d*, with a grate *e*, forming a basket-shaped fuel-container for a slow-combustion fire to which fuel may be fed by a shoot *c*. In the non-sectional boiler shown in Fig. 5, the combustion products pass over and down behind the member *g*, and the cross-members *u, v, w* are arranged to provide a gradually ascending path for the water.

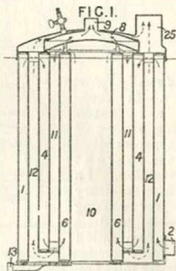
**21,547. Kestner, P.** Sept. 23, 1911, [Convention date].

*Feed-water, heating.*—Feed-water is distributed along the whole length of the upper drum of a water-tube boiler by a trough 6, from which the water overflows through slots vertically above the axis of the drum and is thus heated.



**22,095. Wright & Co., A., Carr, H. O., and Nairne, U. O. S.** Sept. 28. [Cognate Application, 7412/13.]

*Annular boilers.*—Water to be heated passes successively from the outside at 2 through hollow cylindrical chambers 1, 4, 6, and thence to a concave chamber 8 and the outlet 9, being heated in transit electrically or by a heater burning any fuel in the central space 10. Waste heat may also be utilized in this way. The products of combustion or the like pass outwardly down and up the spaces 11, 12 to the outlet 25. Condensation water passes out at 13.



**22,097. Keith, J., and Bain, D. B.** Sept. 28. Drawings to Specification.

*Heating air.*—Relates to tubular apparatus of the kind in which the steam or vapour employed for heating is passed through the tubes, and consists in disposing the tubes at an inclination to the direction of the current of air, thereby enabling the water of condensation to flow away quickly from the surface exposed to the flow of the air.

**22,137. Wolf, R.** (Firm of). Dec. 20, 1911, [Convention date].

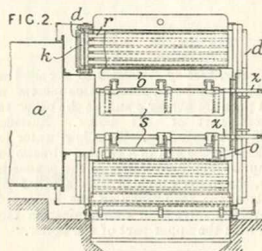
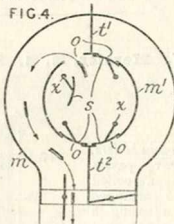


FIG. 4.



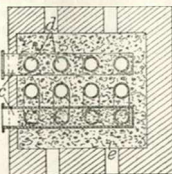
*Feed-water, heating.*—The tubes *r* of the heater fill the annular space between the outer and inner casings *m, m'* and open into annular headers *k* provided with covers *d*. The heater is connected direct to the boiler or superheater casing *a*. Removable plates *t', p* and flaps *s* pivoted at *z* and controlling openings *o* are provided so that one half of the heater can be cut out if required or any desired circulation of the hot gases through the heater or halves of the heater may be obtained. These baffle arrangements are shown diagrammatically in Fig. 4.

**22,305. McCourt, C. D., and Radiant-Heating, Ltd.** Oct. 1.

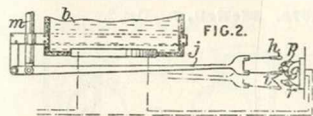
*Water-tube boilers; heating liquids.*—Heat developed by the process known as surface combustion,



communicated to a bed or mass of refractory material such, for example, as *e*, is transferred to a similar bed or mass in contact with which is the fluid to be heated. In the Figure, this second bed is shown enclosed in tubes *c* connected by conduits *d*. The heating and heated fluids may be interchanged. Specifications 4362/10, 11,865/10, 17,650/10, [Class 39 (iii), Heating by electricity], 625/11, 2404/11, and 25,808/09, 29,430/09, 5936/12, and 19,490/12, [all in Class 51 (i), Furnaces &c., Combustion apparatus of] are referred to in respect of the process of surface combustion.



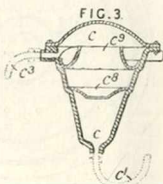
**22,546. Berry, A. F.** Oct. 3.



*Heating water.*—Current supplied at low rates for protracted periods for heating water in the reservoir *b*, described, for example, as that of a domestic hot-water supply system, is cut off or reduced suddenly, or the circuit is reconnected according as the temperature of the water causes the metal reservoir itself to expand. An additional reservoir for storage may be used side by side with, and connected at top and bottom to, the main tank *b*.

**22,594. Ferguson, J. J.** Oct. 4.

*Instantaneous water-heaters.*—In a system for heating by hot water, a boiler *c* is employed having a supply pipe *c'* connected to its upper part and also to a tank-filled set of radiators, and a trap bend discharge pipe *c''* connected to its lower part

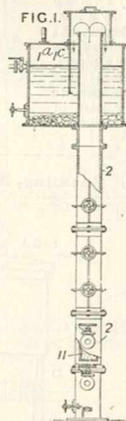


and discharging into an open overhead cistern. From the situation of the feed-pipe *c'* it follows that air is entrapped in the boiler. A fire below heats the boiler, the upper part of which rises to a high temperature. The entrapped air drives out the

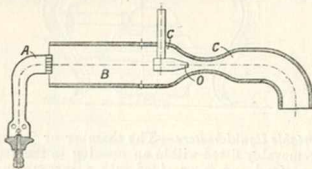
water in the lower part into the overhead cistern, more water flowing in from the pipe *c'* which, causing a slight contraction in the air, draws in more water. This water is heated by flowing over the heated rings *c*, *c'*, and the action recommences. The boiler may be in the form of a wide bore spiral tube.

**23,522. Gariier, L. Savary.** Oct. 18, 1911, [Convention date]. [Addition to 30,378/10.]

*Heating water.*—Water issuing in the form of fine drops from a perforated plate 11 is carried upward by a blast of steam in the column 2, and the separation of impurities takes place in a tank 1 at the upper end of the column. A partition 1<sup>a</sup> enables purified water to be drawn off from the compartment 1<sup>a</sup>.



**23,523. Méker, G. A. H.** Oct. 16, 1911, [Convention date].

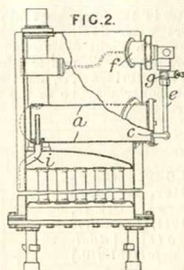


*Heating water.*—Water to be heated is projected from a single jet nozzle *O* into an arrangement of convergent divergent cones *C, C*, so as to draw the products of combustion from a burner *A* through an extension *B*, to mix intimately with the water.

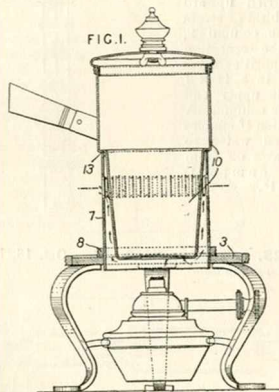
**24,170. Still & Sons, W. M., and Still, E. H.** Oct. 22.

*Feed-water, heating.*—Deposits in culinary boilers, especially those used for making tea, coffee, or like infusions, are prevented by first heating the water in a closed vessel *a* of considerable capacity arranged below the water level in the boiler.

The vessel passes through the wall of the boiler and is provided with a removable cover *c*, to which the water-supply pipe *e* is connected. The water supply is controlled by a valve *g* operated by a float *f* in the boiler. At the rear end of the vessel *a* is a pipe *i*, which leads the purified water to the lower part of the water space.



26,126. Suckling, J. Nov. 14.

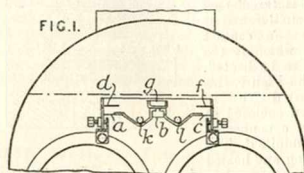


*Portable liquid-heaters.*—The chamber or jacket 7 is removably fitted within an opening in the top 3 of a stand and is provided with a surrounding flange 8 adapted to rest on the top. The vessel 10 has a reduced lower portion and a shoulder 7 which rests upon the upper end of the jacket 7.

26,889. Bessonoff, S. Nov. 22.

*Feed-water, heating.*—A device for purifying feed-water for steam-generators by passing steam bubbles through it consists of an arrangement of troughs so placed in the water-space of the generator that the steam generated below it accumulates in spaces under the troughs and forces its way through slots in the troughs and through the water therein, thus preventing the escape of water through the slots. In the form shown,

there are two troughs arranged between angle-irons attached to the boiler flues, the slots *a*, *c* being formed by the spaces between the troughs and the angle-irons and the slot *b* by the space



between the troughs. Over the slots *a*, *c* are horizontal baffles *d*, *f* and over the slot *b* a trough *g* into which the feed-water is first led, overflowing from the trough *g* into the purifying-troughs. The troughs may be formed of sections, the end of each section fitting into the next. Perforated blow-off pipes *k*, *l* are arranged in the purifying-troughs.

27,675. McNeil, J. Dec. 2.

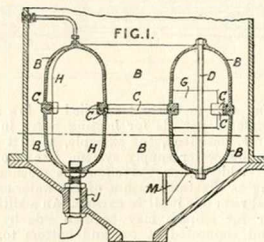
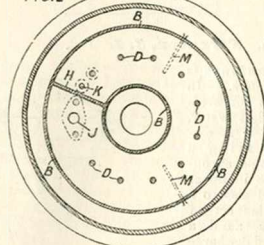


FIG. 2



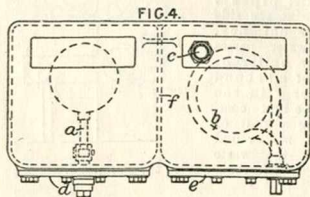
*Heating liquids.*—A steam-heater, especially adapted for evaporating and concentrating liquids, consists of an annular chamber of an approximately elliptical cross-section and provided with a radial partition separating the steam inlet from the

outlet for water of condensation. The chamber B is made in two parts provided with interlocking flanges C and held together by bolts D. The partition H separates the steam inlet J from the water outlet K. The heater may be strengthened

by internal ribs G and supported on brackets in a vacuum-pan or the like. Vertical tubes for circulation of the liquid to be heated may pass through the heater.

**27,823. Slater & Co., J., and Allensby, C. R.** Dec. 3.

*Heating water.*—A boiler for hot water for making tea &c. consists of a rectangular body with a division plate *f* forming two equal compartments communicating with one another above and below the plate. One contains a float and lever *a* for actuating the water-inlet valve, and the other a steam-coil *b*. Hot water is drawn off when the internal pressure rises on account of the steam generated, a pipe *c* being provided. The valve *a* and coil *b* are fixed to the cover plates *d*, *e* of their respective compartments, and these may be interchanged.

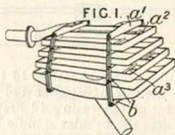


**28,259. Collier, E. B. M.** Dec. 7. *Drawings to Specification.*

*Heating air.*—Air for drying casks and barrels is heated by passing it through a vessel containing heated asbestos blocks. The blocks are normally

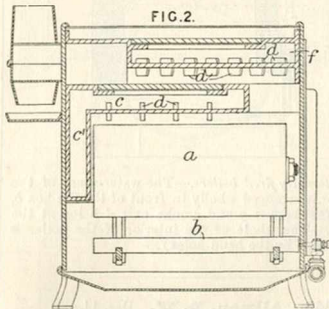
coated with a viscous substance, such as glycerine, for sterilizing air and are heated to burn off the coating when it becomes foul.

**28,395. Coke Oven Machinery Co.**  
Dec. 9. *No Patent granted (Sealing fee not paid).*



*Feed-water, heating.*—In apparatus of the kind in which the feed-water passes over a series of horizontal trays placed in the boiler steam space, the trays are so mounted that they are separately removable. The trays may have inwardly-inclined sides. In the apparatus shown, the trays rest upon cross-bars *b* in supporting-frames attached to the boiler shell. Lugs may be provided on the bottom of the trays to engage with the sides of the cross-bars. Each tray is divided by a longitudinal partition *a*<sup>1</sup>. Overflow openings *a*<sup>2</sup> are provided at opposite ends of consecutive trays. Ledges *a*<sup>3</sup> in front of the openings maintain a uniform level in the trays.

or 52/12 is combined with a saddle-shaped casing *c* having end parts *c*<sup>1</sup> so that water flows through the casing and is pre-heated therein before passing to the boiler proper *a*. The hot gases from the



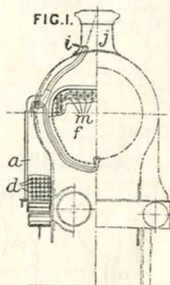
burners *b* may be further utilized by the employment of another water chamber *f* arranged above and in communication with the casing *c*. Ribs *d* are provided to facilitate heat conduction.

**28,494. Stimson, E. F.** Dec. 10.

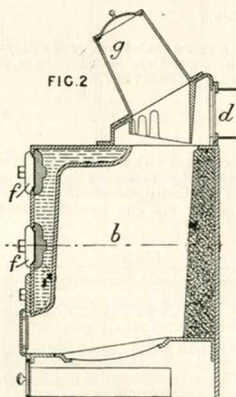
*Internally-fired boilers.*—A cylindrical boiler *a* constructed according to Specifications 29,011/11

28,512. Smith, F. G. Dec. 10.

*Feed-water, heating.*—External feedwater-heaters are placed in juxtaposition to the engine cylinders are heated by the exhaust steam in tubes *d* which passes thence to blast pipes *i* placed at the side of the chimney. Feed-water passes to the boiler by way of a second heater *f* in the smoke-box comprising a nest of tubes *m* around which the waste gases pass on their way to the chimney *j*.



28,622. Jenkins, E. J. Dec. 12.

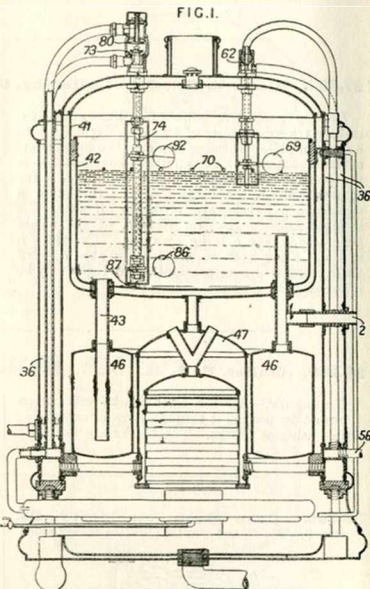


*Internally-fired boilers.*—The water-space of the boiler is arranged wholly in front of the fire-box *b*, the fuel-hopper *g* and smoke exit *d* being at the back. The whole of the interior of the boiler is accessible by the hand-holes *f*.

28,845. Allman, D. W. Dec. 14.

*Internally-fired boilers.*—The supply of heating-medium to a boiler is controlled by the water so that, on the level falling or rising beyond two pre-determined points, the supply is shut off. Water enters at 56, passes the float-controlled valve 62, and

fills the outer casing 36; from here it flows to the heating-element 47, thence upwards to the chamber formed between the casings 41, 42, gaining admittance to the inner casing 42 through perforations 70



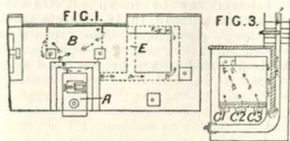
and to the annular water chamber 46 by way of the pipe 43. In the case of a gas-heated boiler, the rising of the water in the casing 42 first lifts the float 86, which raises the tubular spindle 74 and the valve 73. Gas can now flow to the main burner past the normally open valve 80. A suitable level of water having been reached, the float 69 cuts off the supply. Under the influence of the heating, the volume of water in the heater expands until, at a suitable temperature, the expansion of the water lifts the float 92 and the rod 87, thus closing the valve 80 to the burner. Hot water can be drawn off from the pipe 2. The boiler may be heated by electricity, switches being substituted for the valves.

29,543. Stratton, H. W. Dec. 23.

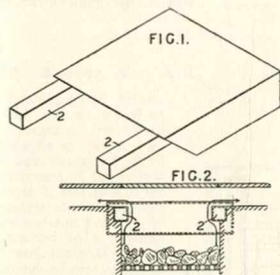
*Washing-boilers.*—In an arrangement for heating a washing-boiler and ovens by one fire, the fan *B* is mounted at the back of the furnace *A* and the flues round the ovens communicate with the fire by three throats *C1*, *C2*, *C3*, Fig. 3, on each side.



The chamber E on the side of each oven nearest the fire communicates with the flues at the bottom only.



29,877. Shaw, J. M. Dec. 28.



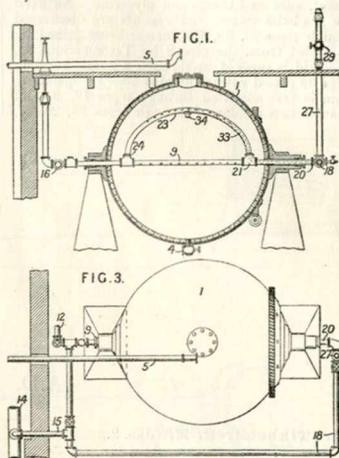
Block-form boilers have one or a pair of forwardly-projecting box-like elements 2, which occupy materially less than half the depth of the fire-place and are arranged so that they partly overlay the fire, and are partly embedded in the wall of the fire-place, so that all the fire-gases pass over them to the oven &c. flues.

30,072. Tomlinson, G. H. Jan. 29, [Convention date].

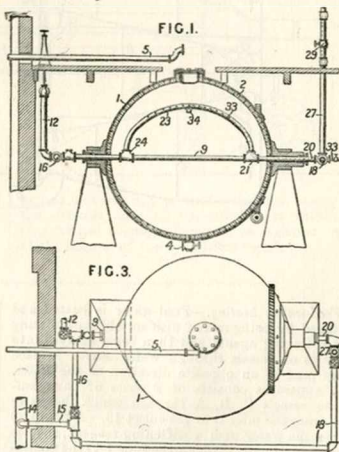
*Digesters.*—Apparatus for producing fermentable sugars from sawdust &c. comprises a rotary digester 1 lined with acid-proof bricks set in a cement, such as litharge and glycerine. An axial pipe 9 admits steam, and vapours are discharged through pipes 23, 20, the former being joined to, but sealed from, the pipe 9 by T-connexions 21, 24. Acid is sprayed in through a nozzle 34 upon a pipe 33 placed within the pipe 23. In operation, steam is first admitted through pipes 12, 9 and exhausts to a condenser through pipes 23, 20, 27. A valve 29 is then closed, acid is sprayed in, and the material is digested under steam pressure. Preferably, a number of digesters are connected so that vapours may be blown off from one digester through pipes 18, 15, 14, and into another digester through pipes 16, 9. The vapours may also blow off through a cock 4 and pipe 5. The valve 29 is provided with a by-pass fitted with a safety-valve.

(For Figures see next column.)

30,072.



30,073. Tomlinson, G. H. Jan. 29, [Convention date].



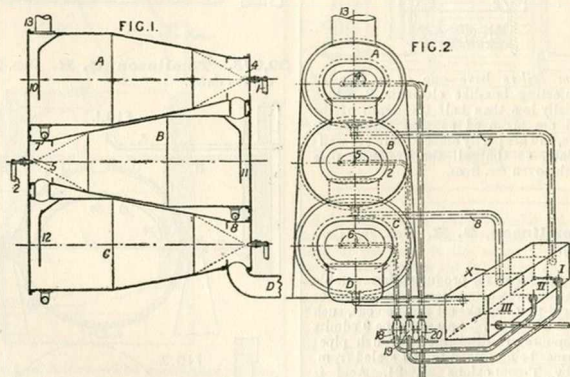
*Digesters.*—Apparatus for producing fermentable sugars and, in the case of resinous woods, turpentine &c. from sawdust &c. comprises a rotary

digester 1 lined with acid-proof bricks set in a cement, such as litharge and glycerine. An axial pipe 9 admits steam, and vapours are discharged through pipes 23, 20, the former being joined to, but sealed from, the pipe 9 by T-connexions 21, 24. Acid is sprayed in through a nozzle 34 upon a pipe 33 placed within the pipe 23. In operation, steam is first admitted through pipes 12, 9, and exhausts to a condenser through pipes 23, 20, 27.

A valve 29 is then closed, acid is sprayed in, and the material is digested under steam pressure. Preferably, a number of digesters are connected so that vapours may be blown off from one digester through pipes 18, 15, 14, and into another digester through pipes 16, 9. The vapours may also blow off through a cock 4 and pipe 5. The valve 29 is provided with a by-pass fitted with a safety-valve.

A.D. 1913.

131. Tikhomiroff, N. Jan. 2.

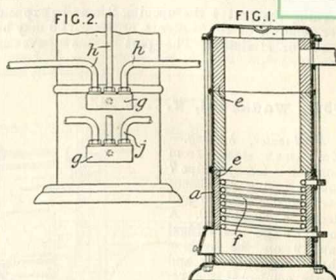


*Feed-water, heating.*—Feed-water is heated and softened by being mixed with suitable coagulating and softening agents and then being sprayed into a series of vessels through which waste furnace gases pass in an opposite direction to the water. The apparatus consists of a series of communicating vessels C, B, A through which the gases pass from the inlet D to the outlet 13. A pump 20 forces the water with a softening-reagent, such as sodium carbonate, through the pipe 1 to the nozzles 4 whereby it is sprayed into the vessel A. The partly heated water is then withdrawn by a pipe 7 connected to the compartment I of the reservoir

X, whence it is withdrawn by a pump 19 and forced through the pipe 2 and sprayed by the nozzles 5 into the chamber B. A pipe 8 connects the chamber B with the compartment II of the reservoir, whence the water is forced by the pump 18 into the first chamber C by the nozzles 6, through which a coagulating-agent, such as aluminium sulphate, is simultaneously supplied. The water withdrawn from the chamber C is passed to the compartment III of the reservoir and is then passed through a sand filter. Partitions 10, 11, 12 are placed in front of the outlet from each chamber.

469. Tice, B. Jan. 7.

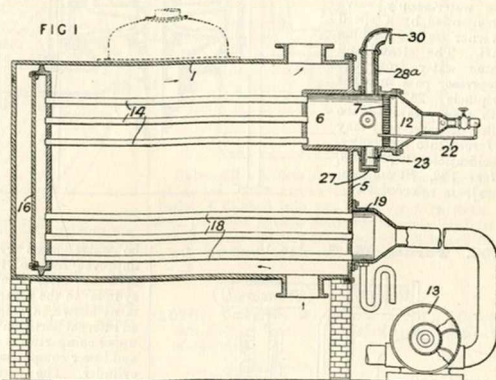
*Water-tube boilers.*—A closed water-heating stove has a metal casing *a*, Fig. 1, a fire-brick or like lining *e*, and a water-coil *f*, the whole of which is freely exposed to the heat of the combustion products. The upper part of the lining may be thickened to ensure the free fall of the fuel from the upper to the lower part of the stove. The stove may be in sections, as shown, and may have a coil in the intermediate or further sections. The inlet and outlet of the coil are fitted with collecting and distributing boxes *g*, Fig. 2, to which are connected the outlet pipes *h* and return pipes *j* of a system of pipes for heating domestic or horticultural buildings by hot water.



549. Rector, A. Jan. 8.

*Internally-fired boilers.*

—Gas and air mixed at a pressure less than atmospheric enter an air-tight chamber 6 placed in advance of the burner proper 7, and pass in the example shown through two series of tubes 14, 18 connected to a chamber 16 and make their exit through a lower casing 19 in communication with a suction device 13. Both chambers 6, 19 are borne by an end plate 5 in the water-holding casing 1. A pilot tube 22 supplies gas for a lighting-flame, air to support the combustion of which enters through a tube 23, closed during the working of the main burner by a loose plate 27 drawn up by the suction. An exit tube 28<sup>a</sup> for the products

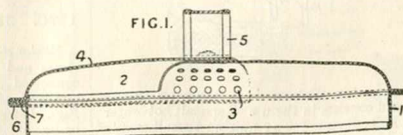


of combustion of the pilot flame is similarly closed by a hinged flap 30. A modification is described in which the burner and its chamber are annular in form; the tubes are U-shaped and

extend upward in a vertical cylindrical casing and the exhaust ends of the tubes pass within the ring burner chamber down to an exhaust casing at the bottom of the cylindrical vessel.

620. Gittins, G. Jan. 8.

*Washing-boilers &c.*—A lid or cover for large vessels for washing clothes has a base part 1 with a substantially semi-circular opening 2 and an adjacent perforated part 3, normally covered by an approximately semi-circular cover member 4 provided with a handle 5, whereby the whole cover may be removed, while by

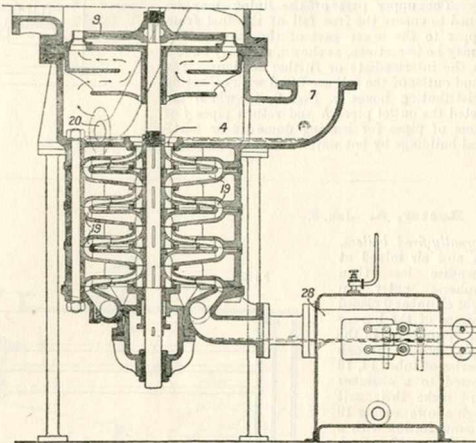


turning the part 4 the opening 2 may be exposed for removal of the contents, or the part 3 may be used for straining. The part 4 may have an

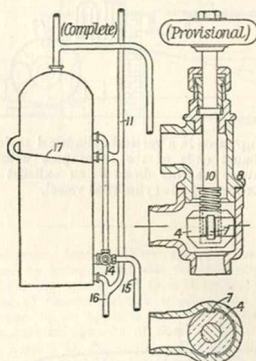
overturned rim 6 to engage the rim 7 of the member 1, or it may be pivoted to the centre of the part 1 by a rivet or a bolt and nut.

957. Wadagaki, Y. Jan. 13.

*Feed water, heating.*—Exhaust steam from engines is led by a pipe 7 into a casing 4, whence part of it passes to and drives a turbine 9. A multi-stage centrifugal fan 19 on the turbine shaft compresses and partly condenses the remainder of the steam with the aid of condenser water supplied by a pipe 20, and allowed to trickle through the compressor. The water-supply valve is controlled by a speed governor on the turbine shaft. The steam and heated water from the compressor pass into the receptacle 28, whence both may pass into the boiler, or water only may be forced into the boiler. Specification 28,224/08, [Class 132, Steam engines], is referred to.



1108. Turner, M. S. Jan. 15.



*Heating water.*—Relates to a hot-water supply system and consists in the use of a small hot-water store cylinder for purposes requiring a small supply of very hot water in combination with a large

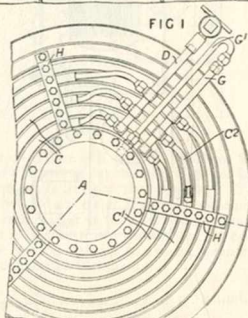
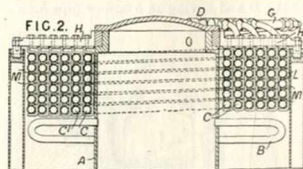
hot-water store cylinder for general uses, an improved form of three-way diverting-valve being used to alter the connexions from one store cylinder to the other, as required. In the arrangement shown, a single cylinder is used divided by an internal partition 17 with connexions so that the upper compartment can be used alone, or the upper and lower compartments together as a single large cylinder. The three-way diverting-valve is indicated at 14, the supply from the cold-water cistern at 11, the supply to the boiler at 16, and the return from the boiler at 15. The valve 4 is a double-sided lift valve guided by tongues and grooves 7 to prevent rotation during operation by the screw 10. The casing is in two parts with a screwed joint 8 so that it facilitates right or left hand connexions. A back or wall plate may be cast therewith for convenience in fixing to a wall.

1270. Clark, T. Jan. 16.

*Feed-water, heating.*—In a boiler having a vertical steam and water drum, helical feed-heating coils connected in parallel to two radial headers are arranged around the upper part of the drum. Figs. 1 and 2 show the heating-coils fitted in a boiler of the kind in which U-tubes B project radially from a central drum A, as described in

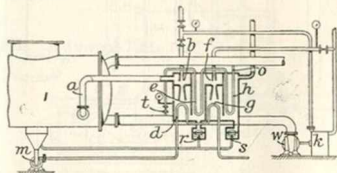


Specification 23,213/07, [Class 123, Steam generators]. The feed-heater is built up of elements consisting of pairs of vertical coils C, C', the ends of which are connected to radial



inlet and outlet headers D, G. The connexions with the headers are made by short lengths of tubing C', which are of smaller diameter than the coil tubing and are relatively flexible. The outlet header communicates with the drum through a detachable pipe G'. The coils are supported by screws M in bars L suspended from radial supports H.

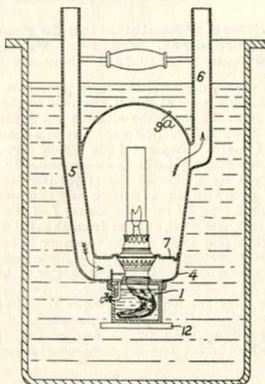
1495. **Josse, E., and Gonsecke, W.**  
Jan. 18



*Feed-water heating.*—A condenser 1 is evacuated by means of a pipe a leading to a number of steam-jet apparatus b, f arranged in series, the condensation of the steam being effected by heat-exchangers d, g through which circulates water of condensation derived from the condenser by a pump m, the water thus warmed being returned

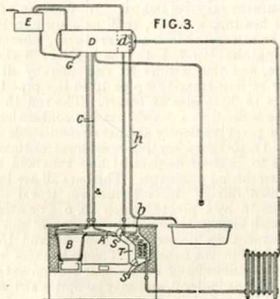
to the condenser 1 by pipes r, s and used as feed-water. Low-pressure steam, such as the exhaust from the turbine k driving the circulating-pump w, is used in the steam jet b and high-pressure steam in the jet f.

1577. **Kluge, A.** Jan. 20.



*Submersible heaters for liquids.*—The reservoir 1 of an oil lamp screws into the lower part of a casing 4 divided into two parts by a partition 7 and provided with a dome top 9. An air inlet 5 and a smoke outlet 6 are attached. A heavy base-plate 12 is fixed to the oil-reservoir 1.

1576. **Cuggia, J.** March 6, 1912, [Convention date]. *Void.* [Published under Section 91 of the Act.]



*Heating water; boilers.*—Water for a domestic supply is heated in a coil A mounted over the

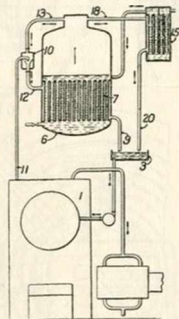


fire-place B and beneath the hot plate of a kitchen range, and water for a radiator system may be heated in a coil *b* disposed in a different place in the range, means being provided to prevent the heating of the coil *b* for the radiator system when desired. The coil A is connected by pipes C with the reservoir D to which water is supplied

from a tank E by a pipe G having a float valve. A flue T may be closed or opened by dampers S, S' at its ends according to whether it is desired to heat the coil *b* for the radiator system or not. The coil *b* is fed from a tank *d* communicating with the tank D and having an overflow pipe *h*.

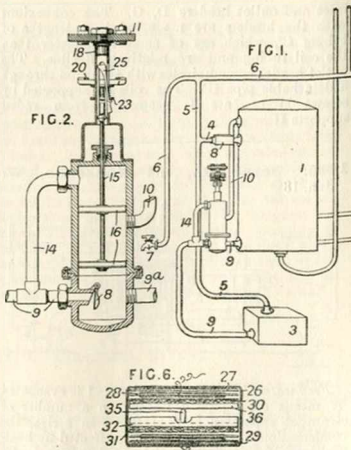
**1593. Soc. d'Exploitation de Procédés Evaporatoires, système Frache & Bouillon.** Jan. 19, 1912, [Convention date].

*Feed-water, heating.*—A steam generator is fed with distilled water at 100° C. obtained by the use of steam from the generator with but a slight increase in the consumption of fuel. The apparatus consists of a steam boiler 1 from which part of the steam is led by a pipe 11 to a compressor 10, which withdraws by a pipe 13 the major portion of the steam generated in a still 6, and compresses it through a pipe 12 into the heater 7 of the still 6. The remainder of the steam from the still 6 passes through a pipe 18 to a heat-exchanger 15 in which the water passing to the still is preheated. The hot condensates formed in the heater 7 and the pre-heater 15 are led by pipes 9, 20 to a tank 3, whence they are fed to the boiler 1. The steam-jet compressor 10 may be replaced by a motor compressor actuated by an engine the exhaust from which mixes with the compressed steam.



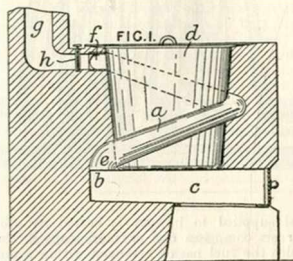
**1678. Needham, V. S., and Needham, F. G.** Jan. 21.

*Heating water.*—A heater or boiler 3 is so connected to a reservoir 1 that, although normally a circulation is established through pipes 5 and 4 to tank 1 and thence by pipe 9 to the heater, on opening the tap 7 check-valves 8 in the pipe 4 and also in the pipe 9 close so that the hottest water from the top of the tank flows through the pipes 10, 9, boiler 3, and pipes 5, 6, being thus further heated before delivery. At the same time, additional heating may be applied to the system, for instance more gas-burners may be lighted. In the case of electrical heating, a device, such as shown in Fig. 2, may be interposed in the water circuit, whereby, on opening the tap 7, both check-valves 8 close as before, and the pistons 16 rise, thereby allowing water to flow from the pipe 10 to the pipe 14 and thence to the boiler as before. The rod 15 raises at the same time a device bearing contact-bars 20, which press resiliently against contact-studs in the plate 11, to cause heating-resistances ordinarily in series to be used in parallel and thus add to the heating during discharge. The bars 20 are held up or down during the intermediate travel of the pistons 16 by a pivoted catch 25, one or other end of which engages with a sliding collar 23 and which is operated by projections upon the rod 15 as it slides within the tube 18. The resistances may be placed in tubes 26 of rectangular section extending through the boiler 3, and may comprise strips 27 of insulating-material and upper and lower resistances 28, 29 of wire coiled round insulators such as mica, the two parts being separated by sheets of asbestos



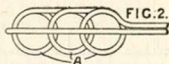
30, 31 and steel plates 32, 36 pressed apart by an oval rod 35.

1691. **Matthews, W., and Matthews, D.**  
Jan. 21.



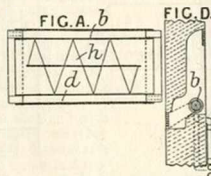
*Boiling-pans.*—A pan *d* is provided with an encircling flue *a* which starts at the back *b* of the fire-box *c* and leads into a flue *g* at the top end *f*. The flue, which is riveted to or cast in one with the pan, is preferably made larger at the lower end *e* than at the end *f*, and is D-shaped in cross-section. A door is placed near the regulator *h* to allow a cleaning-brush to be introduced into the flue.

1956. **Turner, T. J.** Jan. 24.



*Water-tube boilers.*—The tubes *A* are arranged with coils horizontal and lying eccentrically so as to baffle the rising combustion products.

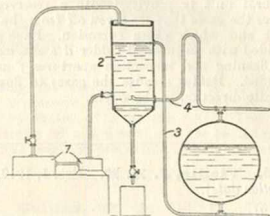
2031. **Hancock, H. H.** Jan. 25.



*Heating air.*—Air for heating and ventilating buildings &c. enters from a grating in the outer

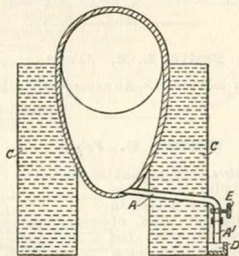
wall and passes through a cylinder *b* having a spiral baffle *h* and an annular jacket *d* for steam or other heating-medium, before making an entrance through a second grating into the room.

2313. **Belorussoff, I.** Jan. 28.



*Feed-water, heating.*—Feed-water for steam boilers is heated and purified in a vessel 2 situated above the boiler and connected with the steam space by a pipe 4, which delivers steam into the water and has an upward bend rising above the water-level in the vessel. The water passes to the boiler through a pipe 3 connected to the upper part of the vessel. The excess steam from the vessel actuates a pump 7 for supplying the water to the vessel.

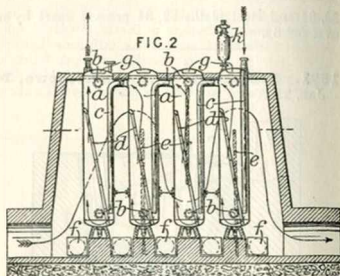
2416. **Penter, N.** Jan. 29.



*Washing-boilers.*—Means for emptying domestic coppers &c. consists of a pipe or conduit *A* passing from the base, through the wall *C*, to a permanent trough or trap *D*, and provided with a cock *E* and with a detachable end piece *A'*, by removing which the liquid may be drawn off into buckets or other portable receptacles.

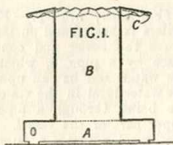
**2496. Soc. Anon. pour la Construction de Rechauffeurs d'Eau à Grand Volume.** Dec. 24, 1912, [Convention date].

*Feed-water, heating.*—In a feedwater-heater comprising a number of large-sized cylindrical units *a*, each of which receives water from the preceding unit by a pipe *b* which has an extension *c* reaching nearly to the bottom of the unit, the first unit is provided with a reservoir *k* to receive the gases that are given off from the heated water and which cause corrosion. Each unit is provided with an internal ladder *d* and a man-hole *g*. Cleaning and inspection apertures *f* are also provided. Baffles *e* cause the gases to flow in an opposite direction to the water.

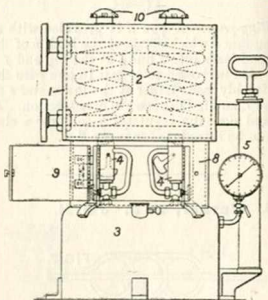


**2573. Vieille, J. E. N.** Feb. 1, 1912, [Convention date].

*Boiling-pans.*—A device, for use in saucepans and other utensils, for promoting connexion currents in the boiling of liquids, particularly juices and milk, consists of a chamber *A* of large diameter but very low surmounted by an open-ended tubular chamber *B* of smaller diameter terminated by a downwardly-inclined radially-corrugated flange *C*. The apparatus may be made in one, two, or three pieces, and may be removable, and the chamber *B* may be telescopic.



fuel supplied to burners is heated by other oil burners comprises one or more coils 2, through which the fuel passes, arranged within a casing 1



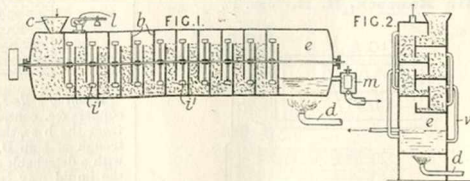
lined with fire-resisting material and furnished with chimneys 10.

**2590. Smith, L. E.** Jan. 31.

*Water-tube boilers.*—An apparatus in which liquid-

**2766. Wolters, G.** Feb. 3.

*Digesters.*—Peat and other pulpy or muddy substances are heated in traversing a series of chambers in which the temperatures and pressures are successively increased, the heating-medium, such as steam or vapours generated from the material, being passed through the chambers in a counterflow. Superheated steam may be fed to one or more chambers, or single chambers may be heated internally or externally. Fig. 1 shows a tubular receptacle or boiler divided into

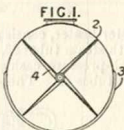


chambers by depending and upstanding partitions *b*, between which the material forms a seal. Feeding-scoops or blades *i* on a central rotary shaft advance

the material ultimately to an end-chamber or boiler *e*, heated externally by a furnace *d* or internally by superheated steam. This boiler may be separate. The material is discharged through an adjustable outlet *m*, and may be used for preliminary heating. Vapours forcing their way backwards through the material may escape through the feed-inlet *c* or a valve *l*, or they may condense in the raw material. Waste gases from the boiler may also heat other chambers. The ends of the partitions *b* may be inclined towards the inlet. Fig. 2 shows superposed chambers formed in a vertical receptacle by shelves and partitions. Mechanical feeding-means may be dispensed with, the material being advanced by gravity. Overflow pipes *v* connect each chamber with that below, to remove any excess of material. A third apparatus comprises a rotary spiral receptacle, in which chambers are formed by the material, without partitions.

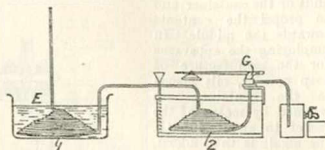
**3064. Ramsden, W. T.** Feb. 6.

*Digesters.*—Brewers' wort is caramelized for flavouring purposes by being heated under pressure in a closed vessel 2 heated by a steam jacket 3 and fitted with a rouser 4 consisting of rigid radial arms fitted with flexible blades of copper or the like which move in close proximity to the sides of the vessel in order to prevent the formation of scale. The wort is heated to 220–280° F. according to the colour and flavour required.


**3413. Renard, G.** Feb. 10.

*Heating liquids.*—Petroleum and other hydrocarbons are transformed into products of lower boiling-points by forcing them in the liquid state through an uninterrupted passage, such as a length of tubing 1, 2, of which the first part 1 is kept at a temperature above the boiling-point of the

petroleum, while the remaining part 2 is cooled, a pressure in excess of the vapour tension of the oil being maintained throughout the coil. A temperature of 400–450° C. is obtained by

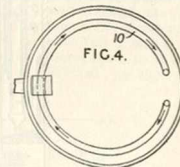
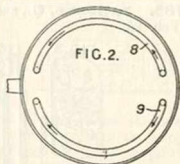


immersing the part 1 in a bath E of molten lead. A pressure of 40–50 atmospheres is maintained by means of a governor G. The tube is preferably of nickel steel, and the heated part 1 is of great length in proportion to its diameter.

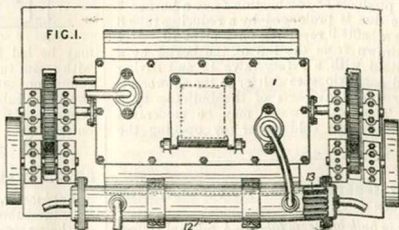
**3919. Collins, W. P.** Feb. 15. [*Cognate Application, 8701/13.*]

*Water-tube boilers.*—Geyzers &c.

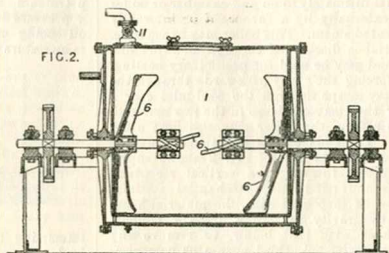
are provided with a single circular tube 10, Fig. 4, beneath the base, or two semicircular tubes 8, 9, Fig. 2, the tubes communicating with the interior of the receptacle and being arranged to slope from their inlets to their outlets. In a modification, the circular tube is a closed ring sloping with reference to the base and having inlet and outlet branches at the lowest and highest points respectively.


**4654. Edwards, K. B., and Rance, H.** Feb. 24. *No Patent granted (Sealing fee not paid).*

*Digesters.*—Apparatus for use in the manufacture of soap, soap powders, cocoa, and chocolate, and in other processes in which ingredients are heated, mixed, dried, and powdered, consists of a jacketed container 1 provided at each end with a rotary shaft carrying mixing-blades 6, the shafts rotating in opposite directions, and a tubulous vessel 12 serving as a heater or cooler for air

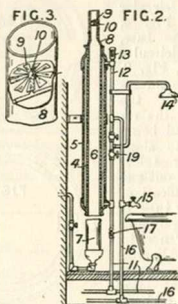


and gases conveyed to and from the container. The blades 6 are adapted to clear the sides and ends of the container and to propel the contents towards the middle. In employing the apparatus for the manufacture of soap powder, oils placed in the container are warmed by means of the jacket to about 45° C., the alkali is then added, and the ingredients are mixed under a pressure of three or four atmospheres obtained by pumping in air through a valved pipe 11. The caustic is then neutralized by the introduction of carbon dioxide, and the mixture, while being agitated, is dried by a current of hot air conveyed to the container by way of the vessel 12, which is heated



by passing steam through tubes 13. When the mixture commences to powder, it is further dried in vacuo, the air-pump being reversed, and cold water passed through the tubes 13 in place of the steam.

**4785. Julienne, C., and Chambers, H. S.**  
Feb. 25.

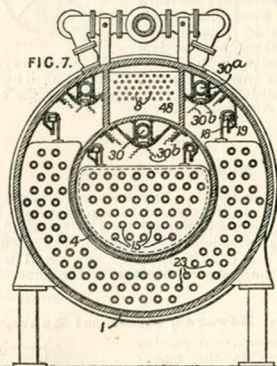


*Annular boilers; water supply and delivery.*—Cold water to be heated passes from the main 11 through a control valve 17 into the annular space between tubes 4, 5 having a central flue 6 through which the products of combustion from a burner 7 pass. The flue is prolonged by a reducing-tube 8 containing a baffle 9 revolving on a pivot 10. Hot water is drawn from the top of the heater by a pipe 12 fitted with a safety-valve 13 and having valves and connexions to deliver to the shower 14, tap 15, or to distant parts of the building by a pipe 16. The heated water may be moderated by admixture with cold water by opening the cock 19.

**5016. Heisserman, G. W.** Feb. 29, 1912,  
[Convention date].

*Heating in bulk by steam tubes.*—A multiple-effect apparatus for distilling water, capable of use as a

water-heater, consists of nested casings 1, 4 fitted with steam tubes 23, 15, the steam generated in the high-pressure casing 4 being led by a tube 30 to the tubes 23. The steam generated in the casing 1

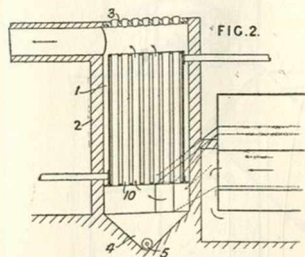


may be led by tubes 30<sup>a</sup> to a preheater 48 fitted with steam tubes 8. The various steam and water connexions are mounted on a removable head, and the steam tubes 15, 23 with their headers are made removable by mounting them on wheels 19 running on rails 18.

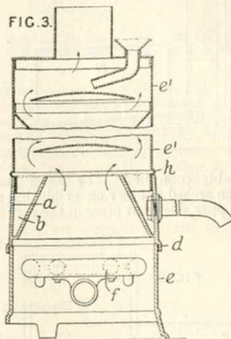
**5077. Meikle, J.** Feb. 28.

*Feed-water, heating.*—A water-chamber 1 fitted with fire-tubes 10 is fixed in a casing 2 in the path of the waste gases. The sides of the casing merge into a V-shaped trough 4, at the lowest part of

which a conveyer 5 is situated to remove soot &c. A cover-plate 3 with plugged perforations closes the upper end of the casing.



5078. Townsend, W. W. Feb. 28.

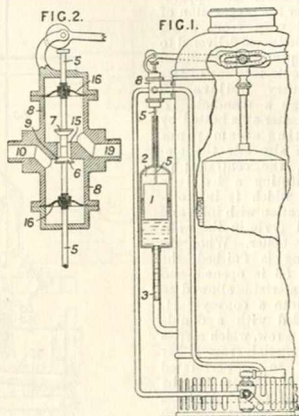


*Heating water.*—In an apparatus for heating water by direct contact of hot gases from burners *f* the receptacle *b* is formed as a detachable unit, the outer wall *a* forming the wall of the geyser at that part and being connected to the body *e'* of the geyser above and to the stand *e* below by simple socket joints *h, d*.

5432. Stott, V. H., and Schofield, L. March 4.

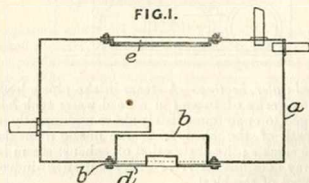
*Heating water; water supply and delivery.*—Relates to a water-heater as described in Specification 6996/12 and consists in the addition of a float adapted to close the supplementary gas or steam supply when sufficient evaporation of the water in the heater has taken place. The supplementary gas supply is controlled by a double-beat valve within

a chamber 8, Fig. 1. This valve is connected by a spindle 5 to a float 1 contained in a chamber 2 connected by a pipe 3 with the main boiler. Evaporation of the water in the boiler lowers the level of



the water in the chamber 2 and causes the float 1 to fall and close the valve controlling the supplementary gas supply. Fig. 2 is a section through the valve-chamber 8. Gas enters at 10, passes between the valves 6, 7, and leaves through the pipe 19. When the float 1 falls, the valve 7 closes upon the seat 15. When the boiler is full of water, the float 1 rises and the valve 6 closes upon its seat 9. The valve-chamber 8 is rendered gas-tight by diaphragms 16.

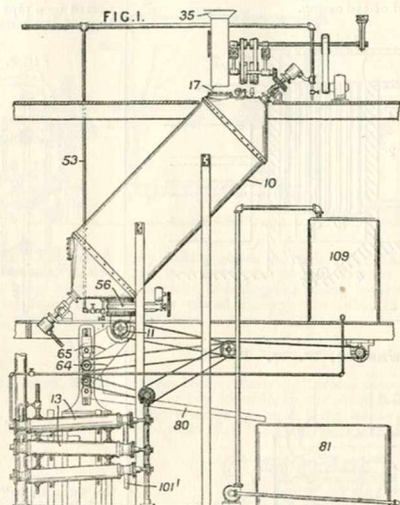
5548. Brain, H. R. March 5.



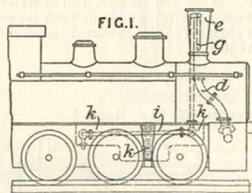
*Heating water.*—A hot-water supply tank *a* has a secondary heating-means in an inwardly-projecting chamber *b* closed by a detachable cover-plate *d*. When electricity is the heating-agent, the plate *d* carries the terminals. If other heating-means are employed suitable flues may extend through the water in the tank. Inspection covers *e* may be provided.

5595. Rice, J. D. March 6.

*Digesters.*—In apparatus for the preparation of paper pulp from wood, chopped wood delivered to a hopper 35 is introduced through a man-hole 17. The material is heated by rotating steam-pipes which also stir the material, the central pipe constituting a hollow shaft which is in communication with inlet and outlet ports in the walls of the boiler. When the cooking is finished, the valve 56 is opened, and the material is allowed to flow into a conveyer 11, provided with a double spiral screw, which carries the material from either boiler to a perforated shoot 65. Steam may be supplied to the bottoms of the boilers through pipes 53.



5660. Rieger, O. March 6, 1912, [Convention date]

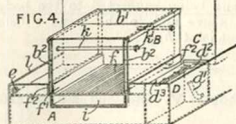
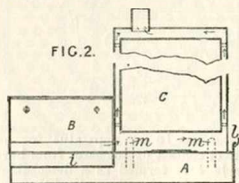


*Feed-water, heating.*—A steam-intake pipe *g* leading to a series of tubes *i* in a feed-water tank *k* is arranged to open immediately above and directly in the path of the blast from the nozzle *d* in the smoke stack *e*; the abstraction of exhaust steam in this way does not interfere with the draught-inducing effect of the blast.

5846. Fowler, G. Sept. 8.

*Block-form boilers.*—A cooking and water-heating stove for use in a camp, a room, or on a vehicle comprises a large rectangular boiler *A*, forming the base of the apparatus, a fire-box *B*, and an oven *C*,

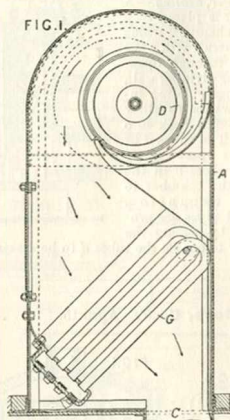
all detachably connected. The boiler *A*, which may have an arched or other underside, has a curb *l* round its upper side, vent pipes in the rear corners,



a well for the ash-pan *i*, an overflow or water-withdrawing pipe *e*, a filling-device *D*, and water-circulating pipes *m*. The filling-device *D* consists of a part with a funnel *a*<sup>1</sup>, and a cover *a*<sup>2</sup> secured by a bolt *d*. The pipes *a*<sup>1</sup>, *e* have caps for closing them when desired.



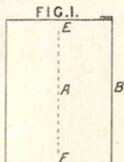
6233. **Keith, J., and Bain, D. B.**  
 March 13. [Addition to 22,097/12.]



*Heating air.*—Apparatus constructed according to the parent Specification is adapted to serve for heating, cooling, and ventilating ships and buildings, as described in Specification 5638/09, by arranging the inclined heat-exchanging elements G and a motor-driven fan D within a casing A provided with a ventilator and connected to an air-trunk system at C. Fig. 1 shows one form with rows of tubes G. In modifications, the casing is cylindrical and the tubes are arranged to rise substantially spirally from annular headers.

6241. **Bailey, G.** March 13.

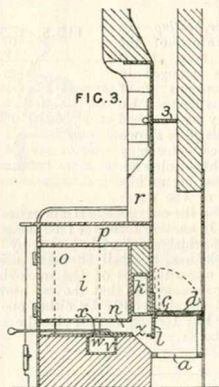
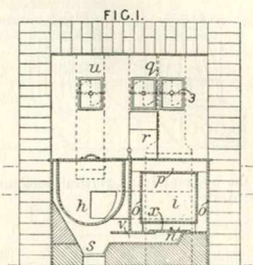
*Slab-form boilers.*—Long and flat boilers B adapted to extend below the level of the fire-grate are fitted with a division-plate A leaving openings at the top and bottom E, F by means of which the two parts of the boiler communicate.



6293. **Massey, C. W.** March 13.

*Washing-boilers.*—An open fire-place arranged in one room may heat an oven and a washing-boiler in an adjacent room; an additional grate is arranged beneath the boiler. When baking &c. is to be done, a damper 3 in the flue of the open fire place *a* is closed, and the combustion products pass beneath a

check plate *l*, through flues *n*, *o*, *p* around the oven *i*, and an offset flue *r* to a damper-controlled flue *g*. The boiler *h* is of the type described in Specification 20,601/06 having an arm *k* extending behind the

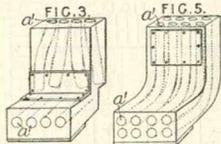


fire-place *a* and thus heated. The boiler *h* may be heated directly by a grate *s* beneath it, the combustion products passing away by a dampered flue *u* or into a flue *v* and around the oven. A sliding damper *x* controls admission to the oven flues, closing alternatively the opening *z* from the fire-grate *a* or the opening *w* from the flue *v*. A pivoted drop-plate *c* with a boiling-ring *d* may be provided over the grate *a*. A feed-tank and a draw-off pipe may be provided in connexion with the boiler.

7453. **Rutter, J. M.** March 29.

*Block-form boilers.*—A stack of small-bore, round, open-ended flame-tubes pass through the water space of a range boiler. In the example shown in Fig. 3, tubes *a'* pass to a recess at the back and a

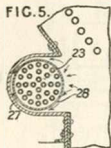
second stack passes vertically through the upstanding part of the boiler. The two parts may be separate and connected by water-tubes, or the flame-tubes may be continuous, as shown in Fig. 5.



Further, the horizontal and vertical portions may be used separately.

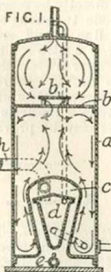
**7517. Kendal, R., and Stone & Co., J.**  
Oct. 28.

*Feed-water, heating.*—In steam-generators of the locomotive type, feed heaters are arranged in lateral extensions 27 of the smoke-box. The heaters may be enclosed within shells 28 as shown and the feed-water may pass through the tubes 23, while exhaust steam fills the casing, or the water may be within the casing while steam passes through the tubes. In another form, the feed passes through the tubes 23 which are directly heated by the gases in the smoke-box, no shell 28 being used. The heaters on opposite sides of the smoke-box may have cross connexions so that the two heaters may be supplied simultaneously by either one of two injectors or like forcing means, placed one on each side of the boiler.



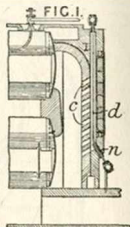
**7677. Potterton, T.** April 1.

*Heating water.*—A hot-water cistern *a* is provided with a cavity *c* at its lower part, in which is fitted the boiler *d* heated by a burner *e*. An outlet flue *h* passes through the side of the apparatus. The upper and lower parts of the boiler and cistern are connected, and baffle-plates *b* are arranged in the cistern.

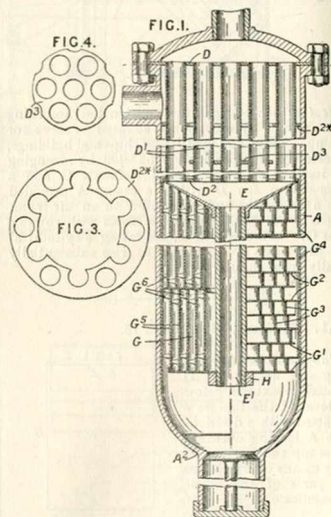


**8643. Buchmann, F., and Weber, H.**  
April 12.

*Feed-water, heating.*—A feed heater is placed in a separate chamber which communicates with the main flue through openings *c* in the dividing wall, the openings *c* being inclined upwards to allow the ash to fall back into the flue. The tubes *d* of the heater pass freely through sockets *n* in the cover of the chamber to allow for expansion. Valves and pipes are provided for by-passing the feed-water to enable the tubes *d* to be cleaned.



**8903. Boys, C. V.** April 15.

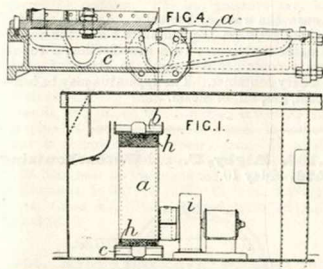


*Boilers.*—A retort for treating liquids, gases, or vapours with heat, accompanied by catalytic action or not, consists of a one-piece outer shell *A* and an insertion, the insertion comprising a heat-regenerator *D* and a heat-treating system *G*, which is disposed around a central conduit *E* and comprises disks *G*<sup>1</sup>, *G*<sup>2</sup>, alternately fitting the conduit *E* and the wall *A* of the retort and separated by distance-pieces *G*<sup>3</sup>, *G*<sup>3</sup>; the arrangement being such that the

fluid passes in succession through the heat-regenerator *D* and the conduit *E*<sup>1</sup>, and then with inward and outward radial flow through the heat-treating system *G* back to the heat-regenerator. The distance-pieces consist of flat helical coils of sheet material on edge and may be either plane, as in the case of the pieces *G*<sup>2</sup>, or formed with spacing-means, as in the case of the pieces *G*<sup>3</sup>, which have radially-disposed tongues *G*<sup>4</sup> made by stamping. The disks *G*<sup>2</sup> may have upstanding flanges *G*<sup>5</sup> lining the wall of the retort, this construction being used when the insertion is made of catalytic material. The disks

*G*<sup>1</sup>, *G*<sup>2</sup> are held on the conduit *E*<sup>1</sup> by a nut *H*, and a valved opening is provided for the discharge of deposits. The heat-regenerator consists of tubes *D*<sup>1</sup> mounted in plates *D*, *D*<sup>1</sup>, the latter welded to a cone *E* leading to the conduit *E*<sup>1</sup>. The plate *D*<sup>2</sup> is hexagonal in form in order to provide communication between the spaces above and below it. Baffle-plates *D*<sup>1\*</sup>, *D*<sup>3</sup> are arranged around the tubes *D*<sup>1</sup>; these plates may be of the form shown in Figs. 3 and 4 so as to be produced without waste of material.

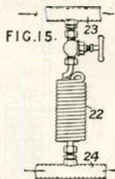
8988. Nesbit, D. M. April 16. [Addition to 16,443/11, Class 137, Ventilation.]



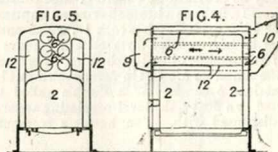
Heating air.—A heater comprising a number of steam tubes connected to a pair of headers *b*, *c*, and enclosed by a casing *a*, is used to warm the circulating air. The air is drawn into the casing *a* through grids *h* by a fan *i*. Fig. 4 shows a convenient form of header *c* and tube-plate.

9029. Constantinesco, G. April 17.

Heating liquids.—In a hydraulic transmission system, in which there are vibrating columns of liquid, the heat generated by the fluid friction may be utilized for radiation, by connecting the two vibrating columns 23, 24, Fig. 15, by a coil 22. If the phase of the vibrations in pipe 23 differs from that in pipe 24, vibrations will be set up in the coil 22. If a generator be used having three sets of pistons differing in phase by 120 degrees, and three sets of liquid columns, then three heating-coils may be used, one end of each being connected to a common chamber.

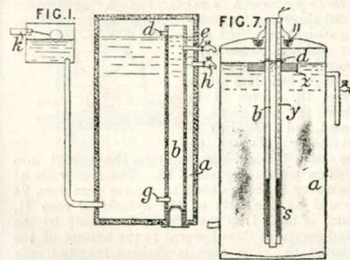


9819. Roberts, A. April 26.



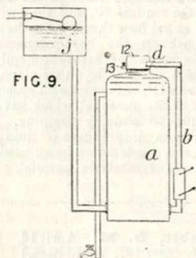
Internally-fired boilers.—Hot gases from the fire-box 2 pass from the rear into horizontal side flues 12 in the water space to a front combustion chamber 9, and thence through a central tank of tubes 6 to the smoke-box 10. Additional and direct communication between the fire-box and combustion chamber may be obtained by small flues.

9930. Weaving, R., and Ferranti, Ltd. April 28. [Cognate Applications, 11,896/13 and 23,527/13.]



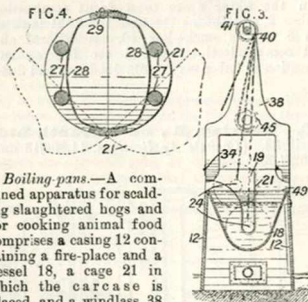
Heating liquids.—A liquid-heater comprises a primary container *b* directly heated communicating at the bottom with a larger secondary container *a* not directly heated, the level in the larger container being maintained slightly below a passage *d* on the smaller container so that liquid can only circulate when a certain temperature has been attained; this ensures a small supply of hot water after heating for a short time, and a larger supply after a longer time. In the heater shown in Fig. 1, the primary

container is inside the secondary and near the wall so that liquid may be drawn off from the top of the primary container by a short horizontal pipe *e*. A tap *h* is provided at the top of the secondary container. The level in the container *a* is kept constant by a float-operated valve *k*. In a modification, the regulating float is inside the container *a*, and the passages *d*, *g* are replaced by rings of perforations. In another modification, the container *b* is tapered at the top, and the lower passage *g* is provided with a back-pressure valve. In another modification, the primary container is external to the secondary container and is provided with an electric heater at the bottom and a reservoir at the top; back-pressure valves are provided at the top and bottom connexions. Two float-chambers in series may be provided to ensure greater constancy of level. Fig. 9 shows a heater having an imprisoned air-space 12, provided with a cock 13, which enables the level to be regulated by a cistern *j* above the heater: in a modification, the chamber 12 is directly above the container *b*. In the form shown in Fig. 7, the container *b* consists of a double-walled tube supported by a float *z*, the level-regulating apparatus being dispensed with. The heater *s* is mounted



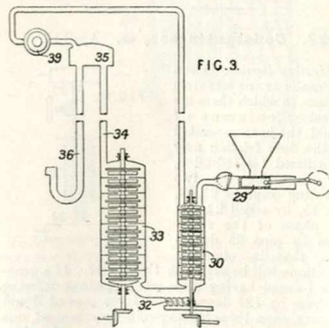
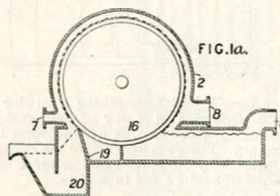
between the walls of the tube. A water-seal 11 is provided between the container *b* and the roof of the outer container. In a modification, a tubular primary container is secured to the roof of the secondary container. The apparatus may be heated by coal, gas, oil, or steam.

10,544. **Burris, E. J.** May 5.



**Boiling pans.**—A combined apparatus for scalding slaughtered hogs and for cooking animal food comprises a casing 12 containing a fire-place and a vessel 18, a cage 21 in which the carcass is placed, and a windlass 38 detachably mounted on the casing 12 and adapted to raise the cage 21 into position within the vessel 18. The side walls of the casing 12 are grooved to receive trunnions 24 formed on the ends of the cylindrical cage 21, which is hauled up the side of the casing by the windlass and is then lowered to the bottom of the grooves 19. The cage is divided longitudinally and opens about a hinge at its lower part in order to allow the hog to be inserted, being locked by a catch 29. The hog is retained by straps 28 and bars 27 facilitate the turning of the cage by hand when it is immersed. The trunnions of the cage 21 are coupled by ropes to the drum 41, which are rotated by ropes from a hand-operated drum 45. A cover 49 serves as a table for use while the carcass is being scraped.

11,133. **Rigby, T., and Wetcarbonizing, Ltd.** May 10.



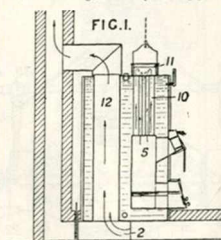
**Heating liquids.**—A continuous stream of peat pulp is partly heated by means of vapour obtained from previously heated pulp or from hot effluent

water. The vapour may be evolved under reduced pressure or may be carried by a current of gas, such as air, which may become wholly or partly replaced by gas liberated from the peat by heat. A current of gas may be circulated through four similar devices, two of which are fed with hot and two with cold pulp. Fig. 1<sup>o</sup> shows one of these devices. Pulp is fed in at 1 and carried round by a revolving drum 16 separated from a casing 2 by a narrow space through which passes an oppositely-moving air current between inlet and outlet pipes 7, 8. Spring-urged packing-rings bear against the sides of the drum to render the narrow space airtight. The pulp is removed from the drum at a partition 19, and flows into a liquid seal 20. When hot effluent water is utilized, transfer of heat to the gas is effected by means of a gas washer, for instance, one in which the stream of liquid is scattered by paddles. The gas pressure over hot material, whether initially above or below atmospheric, may be lowered in stages, the vapour being mixed with fresh material or passed through surface heat-exchange apparatus. Peat may be fed by a piston 29 into a mixer 30, Fig. 3, for preliminary heating, then treated with steam from nozzles 32, and passed into a second mixer 33 and up a pipe 34 into an elevated vessel 35 whence vapour is removed by a rotary pump 39 to the first mixer 30. The pulp then descends through a pipe 36 bent near its lower end to form a liquid seal. Specifications 18,393/11, 5873/13, and 9392/13, [all in Class 50, Fuel, Manufacture of], are referred to.

**11,505. Krupp Akt.-Ges., F.** July 4, 1912, [Convention date].

*Boiling-pans; digesters.*—Vessels for containing boiling lyes are made of nickel steel containing about 25 per cent or more of nickel, and, in some cases,  $\frac{1}{2}$  to 2 per cent of chromium also. The nickel steel may be rendered passive.

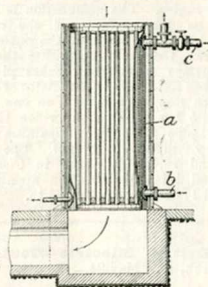
**11,616. Wigand, A.,** [Firm of], and **Schwarz, P.** May 20, 1912, [Convention date]. No Patent granted (Sealing fee not paid).



*Internally-fired boilers.*—Water is heated by the passage of hot gases from the flue 2 through the flue 12. When additional heating is required, a fire is lighted in the furnace 5, the products of

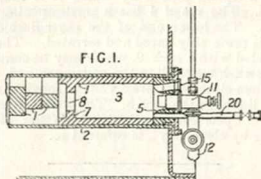
combustion passing through the tubes 10 to a smoke-box and thence downwards through other tubes arranged on either side of the furnace to the flue 2. Dampers 11 are provided for use when the furnace is not in use.

**11,645. Gabriel, J.** May 19.



*Heating air.*—Air for combustion in furnaces &c. is heated by passing downwards through tubes in a tank *a* projecting into the warmer air layers of the boiler or engine house; exhaust steam enters at the bottom at *b* and leaves at the top either to a condenser through the pipe *c* or to the atmosphere. The apparatus also serves as a separator for oil carried by the exhaust steam.

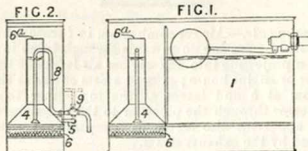
**11,959. McCourt, C. D., and Bonecourt**  
**Surface Combustion, Ltd.** May 22.  
 [Cognate Applications, 11,959/13 and 26,255/13.]



*Internally-fired boilers.*—Feed-water heaters and liquid-heaters in general, of the kind wherein the heat is transmitted to the liquid only through the surfaces of the water-tubes, fire-tubes, and walls separating the liquids from the burning or burnt gases, are heated by the combustion of heavy oils and air introduced, in proportions substantially those necessary for full and complete combustion, into a mixing-chamber wherein combustion begins; the resulting gases issue as a homogeneous combustible mixture, the combustion of which is completed, as surface combustion, on or near the surfaces of masses of refractory material adjacent

to the plates or tube walls of the liquid-containers. Further refractory material is arranged beyond this. Fig. 1 shows such a mixing-chamber 3, refractory material 1, and various accessories arranged in and near a tube 2 traversing a water-space. Fuel such as crude petroleum, petroleum residues, tar oil, &c. is injected by a needle valve 11, and air is supplied by a pipe 12 so as to carry the oil spray into the mixing-chamber 3, wherein combustion begins. The combustion is normally completed on the surfaces of the refractory material 1, but if the walls of the outlet 8 have sufficient area they may constitute the surface whereon surface combustion takes place, the material 1 then acting as a heat radiator or deflector. The partition may have more than one outlet 8. The closure 5 has an ignition orifice 15 and an observation pipe 20. The apparatus may be operated by induced draught. Specifications 25,808/09 and 29,430/09, [both in Class 51 (i), Furnaces and kilns, Combustion apparatus of], 4362/10, and 17,560/10 are referred to.

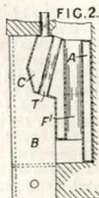
**12,129. British Electric Heater Co., and Kratt, C.** May 24.



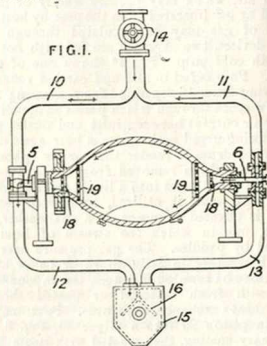
*Heating liquids.*—A liquid-heater comprises a main vessel 1 from which water passes by a pipe 5, preferably containing a non-return valve, to a smaller vessel 4 where it is heated electrically or otherwise, until it expands sufficiently to reach the top of a siphon pipe 8 by which it is then discharged. The vessel 4 has a small opening 6 at the top. The lower end of the inner limb of the pipe 8 is preferably flared and serrated. The pipe is provided with a cock 9, which may be connected with a switch controlling the resistance and which may, when closed, operate a vent to obviate retention of liquid in the pipe 8. The vessel 1 may be heated. Specification 25,296/90, [Class 39 (iii), Heating by electricity], is referred to.

**12,172. Binns, V., and Binns, J.** May 26.

*Block or slab form boilers.*—A boiler for forming a complete fireplace is constructed with side cheeks B extending to the hearth level and a back A having a flue F and a projecting portion C with flue tubes T there-through.



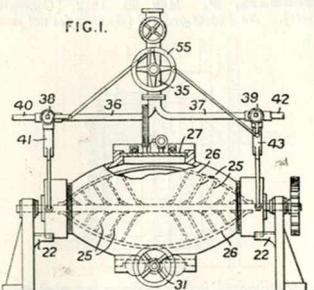
**12,231. Franke, T. O.** Aug. 26, 1912, [Convention date].



*Digesters.*—Peat, ooze, or wood pulp in a vessel is heated, to render it more easily capable of drying by mechanical means, by steam which is passed through the vessel in alternating directions; the material may be agitated. As shown, a rotary vessel is used having sieves 18, 19 at the ends which are provided with tubular extensions 5, 6, connected to supply and exhaust pipes 10, 11, 12, 13 leading respectively to a valve 14 and a condenser 15 having a dirt separator 16. By the rotation of the vessel, a flow of steam is permitted alternately through the pipes 10 and 13 or 11 and 12.

The Specification as open to inspection under Section 91 (3) (a) states also that hot gases may be used in place of steam; this subject-matter does not appear in the Specification as accepted.

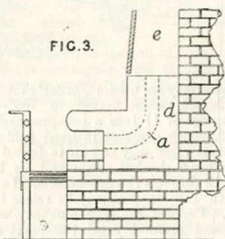
**12,232. Franke, T. O.** Jan. 27, [Convention date]. [Addition to 12,231/13.]



*Digesters.*—In apparatus for treating peat, ooze, and wood pulp with an alternating current of steam, as described in the parent Specification,

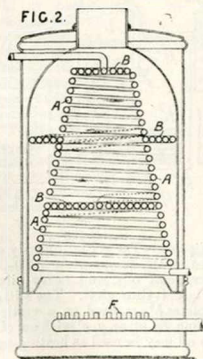
means are provided for stirring, cutting, mixing, pulverizing, and dividing the material. The vessel shown is supported by brackets 22 and has sliding doors 27 operated by screws turned from a hand-wheel 31; its rotary stirrer comprises oblique blades 25 attached to arms 26 following the curve of the vessel. The steam connexions comprise a valved main pipe 35 and branch pipes 36, 37 connected through valves 38, 39, operated by a hand-wheel 55, with pipes 40, 41, 42, 43. The lower ends of the pipes 41, 43 are forked and lead to ports in the ends of the vessel, protected by sieves.

12,535. **McDonnell, R. P., and Egan, T.**  
 May 29.



*Block or slab form boilers.*—A water-holding projection extends over the back of the fire-place and is situated immediately above a flue *a* traversing the boiler *d* and discharging into the main flue *e* as shown.

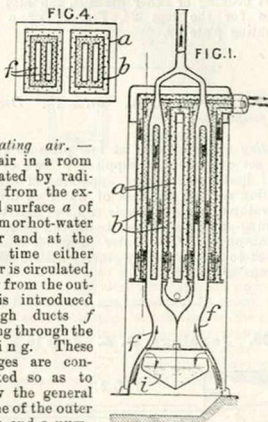
12,989. **Winterflood, J.** June 4.



*Geysers; water-tube boilers.*—The products of combustion from a burner *F* are caused to pass about

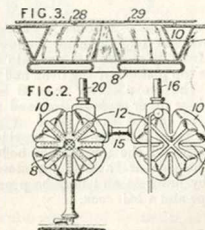
the water tubes *A* in a zigzag path by water-holding baffles *B* which may be tubulous as shown or in water-holding box form.

13,257. **Watzke, F.** June 10, 1913, [Convention date].



*Heating air.*—The air in a room is heated by radiation from the external surface *a* of a steam or hot-water heater and at the same time either the air is circulated, or air from the outside is introduced through ducts *f* passing through the casing. These passages are constructed so as to follow the general outline of the outer casing, and a number are used to increase the inner heating-surface. Baffles *b* may be used to guide the heating-medium substantially in counter-current. An air moistener and dust trap *i* may be fitted.

13,354. **Mills, E. A., Richards, R. H., and Peoples, U. S. G.** June 9.



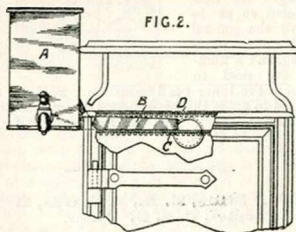
*Water-tube boilers.*—A water-heater adapted to be fitted over the cross-shaped burners of a gas or like cooking-stove consists of a V-section pipe or passage bent tortuously so as to form a device which in plan resembles a four-petaled flower. Fig. 2 shows an underside view of two such

heaters 10 connected by a pipe 15 and fitted with inflow and outflow pipes 16, 20. They are fitted with the apex of the V-section downwards, and are heated by burners 8 with radial arms, which are arranged beneath the cross-like slots 12 and the radial slots 11 formed by the bends of the pipes or passages forming the heaters 10. On the upper surfaces of the heaters are ribs which support cooking or other utensils, and also small recesses for the legs 28, Fig. 3, of a heat-distributing plate 29.

**13,749. Berry, E. A.** June 13. *Drawings to Specification.*

*Heating water.*—Steam at low pressure from a single set of boilers is supplied to two or more sets of heat-interchanging apparatus of different capacities, so that supplies of water at different temperatures, as for example supplies suitable for swimming-pools and slipper baths, can be obtained simultaneously. The water of condensation is returned to the boilers by gravity without the use of pumps, traps, &c.

**13,909. Jennings, G. L.** June 16.

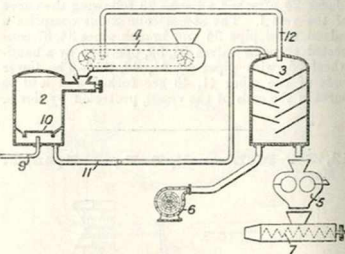


*Block-form boilers.*—A boiler A for a gas-heated cooking-stove has one or more hollow arms B projecting from it at the bottom into the space between the top plate C of the oven and the cover-plate D of the stove. The arms B may be of oblong, oval, or other cross-section, and the top of them may be in the same plane as the boiler bottom. Distance-pieces may be provided on the top and bottom of the arms. The boiler may be placed at the side or back of the stove, may be supported by brackets, and may be provided with a supply-pipe and a ball cock.

**13,924. Anderson, J., and Hippius, J.** June 16.

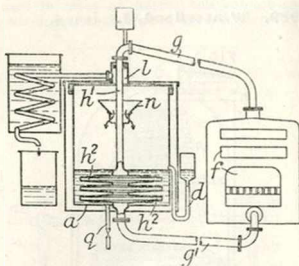
*Digesters.*—Moist vegetable material such as peat is advanced through a preheater 4 by an endless

band to the inlet of a heater or carbonizer 2, into which steam at about 15 atmospheres pressure and 180° C. is blown from a boiler. The steam pipe 9 either enters below a plate 10, or an injector or



hydro-motor may be used, in order that the peat may be forced, when heated to 160°–180° C through an outlet 11 into a low-pressure cooling chamber 3, which contains inclined baffles. Here the peat boils vigorously and air is forced through it by a blower 6, the hot steam and air being led by a pipe 12 through the preheater 4. In the preheater 4, the raw material may be raised to 100° C. or higher. Parts of the apparatus may be used in multiple, and preferably all the parts are close together and enclosed in brickwork to prevent loss of heat.

**14,046. Keller Baugesellschaft Akt.-Ges., Geb.** Feb. 8, [Convention date].

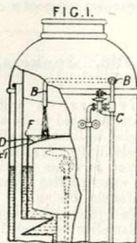


*Heating liquids.*—Tar is continuously distilled in a still heated to the temperature (250–300° C.) at which water, light oils, and heavy oils distill, by circulating hot oil through it. The still a is heated by hollow plates h² arranged on a vertical pipe h¹ communicating by pipes g, g¹ with an oil heater f. Anthracene oil may be used as heating-agent.

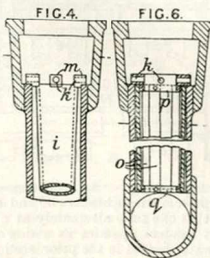


**14,492. Stott, V. H., and Schofield, L.**  
 June 23.

*Water supply.*—In geysers &c. in which the water supply is controlled by steam accumulating in a float or bell and thus raising the float or the water-level outside the bell, the incoming water is caused to fall on the top of the float or bell. The steam is thus condensed and the water supply is cut off, so that the water is supplied intermittently. In the arrangement shown in Fig. 1, the water-supply pipe B discharges on to the top of a float D which controls the water-supply valve C. To retain the water longer in contact with the float, the float may be provided with a raised rim F with a drain-hole F<sup>1</sup>.



internal sheaths or liners. Fig. 4 shows such a sheath *i* arranged to leave a space outside it for the circulation of steam &c. It is suspended from the upper end of the tube by lugs *k* formed with holes



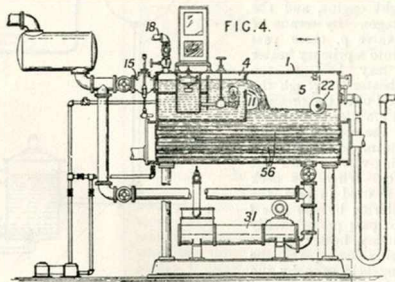
*m* for lifting. The sheath may fit the tube tightly at the top and be supported by a ring instead of lugs. The sheath may be built up of two or more pieces. In the form shown in Fig. 6, an upper ring *p* and a lower ring *q* are connected by pieces *o*, one or more of which may be attached to the rings *p* and *q* and the others held in place between the rings and the tube. The invention is stated to be applicable to tubes of square and other sections, and an application to Galloway tubes is illustrated.

**14,663. Ogden, W. J.** June 25.

*Feed-water, heating.*—To facilitate the removal of incrustation from the tubes of fuel economizers &c. the tubes are fitted with removable tapering

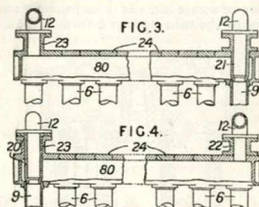
**14,681. Yarnall, D. R.** June 25.

*Feed-water, heating.*—Intake water from any source, cold or heated, enters the compartment 4 of the measuring-device 1 and flows over a weir 11 into a catch-basin or storage compartment 5 which extends under the water-receiving compartment 4. Thence it is pumped to the boiler. The quantity of water flowing over the weir is measured in any ordinary way. When the water is heated in the storage chamber, as for example by steam tubes 56, make-up water enters the measuring-compartment by the pipe 18. A float 22 is connected to valves which control the water-inlet valve 15 and the pump 31 for discharging water to the boiler. When the make-up water enters the



meter, it is also controlled by the float 22 through a lost-motion connexion so as only to come into operation when there is a permanent shortage.

15,087. Krüger, J. J. June 30.

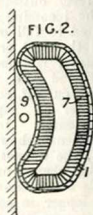


*Feed-water, heating.*—An economizer of the ordinary type comprising headers 80 and tubes 6 is adapted so that one tube alternately at either end of adjacent headers operates as a down-comer 9 conveying water heated in the prior section to the bottom box of the next section. In Fig. 4, at the end of the box 80, where there is a flanged connexion 23, a flanged tube 20 is inserted, and at the other end of a section fitted with such a tube an ordinary connexion 22 is attached over the cleaning-hole above the end tube after removal of the usual plug 24. When the tube to be converted into a

down-comer is at the other end, as in a section adjacent to that shown in Fig. 4, a fitting 21 is employed inserted in the cleaning-hole. U-pieces 12 connect adjacent sections.

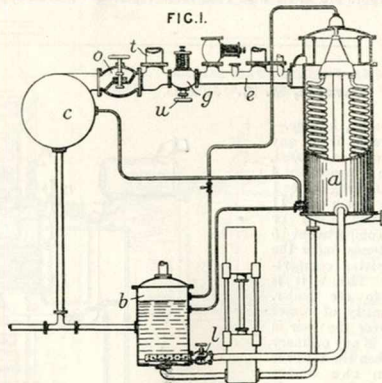
15,196. Junkers, H. July 5, 1912, [Convention date].

*Geysers.*—A water-heater adapted to be suspended against a wall is substantially kidney-shaped in cross-section, the water passing through a double casing 1. A baffle 7 comprises a series of lamellae connected to the inner casing and conducts heat from the hot gases rising from a burner. The water and gas supply-pipes may be passed down in the space 9 between the casing and the wall. In a modification, the shape in cross-section is slightly altered, also the outer or inner surface, or both, may be corrugated.



15,413. Morison, D. B. July 4. [Addition to 3499/12.]

*Feed-water, heating.*—In a feed-water heating-system for use on board ship and under normal conditions, as on a voyage, a pipe *c* receives all the available exhausts such as those from the feed, air, and other pumps, the evaporator, the electric-light engine, and the water drainages. By means of a control valve *g*, these pass preferably into a primary heater *a* and it may be into the secondary heater *b* through the loaded valve *l* until the pressure exceeds the predetermined limit, whereupon the control valve *g* lifts and steam passes through the deflecting-valve *o* into the condenser *c*. When the deck machinery is used in port, the exhaust entering by the pipe *t* is caused to pass preferentially to the primary heater by the valve *o* being loaded and the valve *g* being held open by the handle *u*. In a modification, the steam not used for heating is by-passed from the primary heater



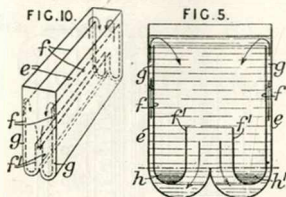
for use in a turbine, and when not so used is discharged to the condenser as before.

15,949. Preinsler, C. L. Jan. 28, [Convention date].

*Washing-boilers; block-form boilers.*—Vessels for

heating or evaporating liquids or for steam-generators are constructed so that the parts in contact with the heating-medium are, in section, of the form of a section of the lower half of a torus.

the generating-circle of which is tangential to the axis. Thus, in vessels of circular horizontal cross-section, as for example the pan or evaporator *e* shown in Fig. 5, the bottom is in-curved to a point



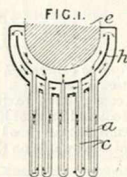
and this point may be stayed to a lid or cover by a rod or tube. In vessels of rectangular horizontal cross-section, as shown in Fig. 10, a ridge extends the length of the bottom, which in this case takes the form of two half-cylinders. In all cases, circulation plates *f* may be fitted, parallel with the walls and so disposed that, for example in Fig. 5, the annular cross-sectional area *g* between the cylinders *e*, *f* is equal to the cross-sectional area of the cylinder *f*. The liquid then circulates on the application of heat in the direction of the arrows with constant speed past the heated surfaces, sediment, if any, being deposited in the annular space *h*, *h*<sup>1</sup>.

### 16,925. Bottger, C. W. July 23.

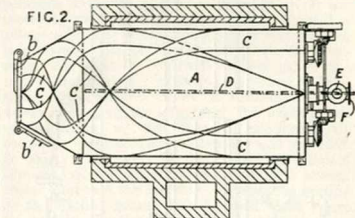
*Heating liquids.*—In heating, drying, and distilling apparatus, bakers' ovens, &c., in which closed tubes containing a liquid are used, one end of the tube being placed in a furnace &c. and the other in the space to be heated, the tubes are filled with naphthalene or with a mixture of naphthalene and other hydrocarbons having a molecular constitution of the ring type, free from oxygen, and having a critical temperature above that of water.

### 17,334. Higgins, E. B. July 28.

*Washing-boilers; water-tube boilers.*—A jacketed pan *e* is heated by circulation in one direction only of oil heated in a field-tube heater *a*, *c* either integral with the jacket or separate. The flow and return to the heater are separated by a partition *h*, and the tubes are so connected to this partition that the flow past the pan is either downwards as shown, or upwards.

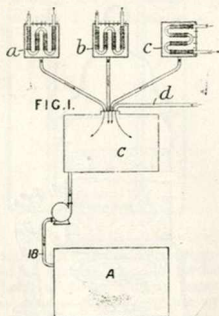


### 17,594. Herrmann, G., and Fraser & Co., W. J. July 31.



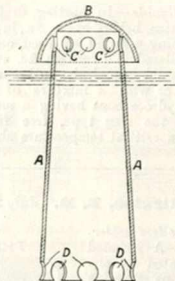
*Digesters.*—In the manufacture of fertilizers leather, wool, &c. are treated with acid under heat and pressure in a closed rotary vessel provided with blades arranged to distribute the material through the vessel and to discharge it when the direction of rotation is reversed. The blades *C* draw the material into the vessel *A* through hinged or sliding doors *b* which can be tightly closed. The blades *C* are of helical form, gradually increasing in pitch so as to distribute the material through the vessel. A perforated pipe *D* for spraying in acid, a chimney *E* with means for closing, and a sampling-opening *F* are provided. The vessel *A* is enclosed in a furnace.

### 16,315. Borislavsky, M. July 15.



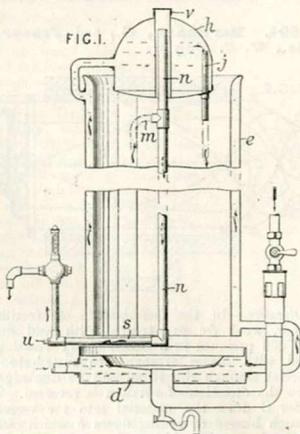
*Heating air.*—The air supplied to apparatus *A* for drying, cooling, or destroying parasites in grain by a pipe *18* is drawn through a mixing chamber *C* from a high-temperature supply *a*, a moderate temperature supply *b*, a cold supply *c*, or from the atmosphere at *d*.

18,305. Walker, C. W. Aug. 12.



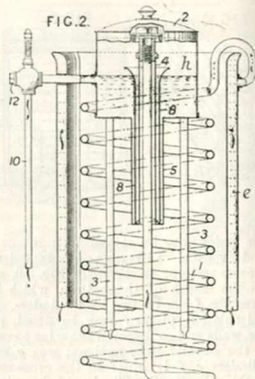
*Washing-boilers.*—A device for promoting circulation comprises a light conical casing A or like construction having large perforations D at the foot and smaller holes C at the top, covered by a hemispherical hood B to direct the uprising liquid downwards on the clothes &c. to be treated.

18,736. Shannon, J., and Hammond, F.  
Aug. 18. [Cognate Application, 4216/14.]



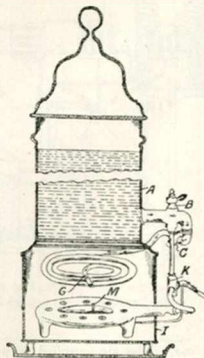
*Internally-fired boilers.*—A water-heater having connected lower and upper casings *d, e* has also a coiled-tube heating-surface, the final heating of the water taking place in a straight-tube arrangement which can easily be cleaned out through plugs and covers *u, v*, Fig. 1, or 12, 2, Fig. 2. In the arrangement shown in Fig. 1, water passes from the lower casing *d* to the upper casing *e* and thence to a

reservoir *h*, from which it flows by an exit *j* through a coiled pipe within the casing *e*, and finally by joint *m* to the straight-pipe system *n, s* and the discharge. In the example shown in Fig. 2,



the water passes from the casing *e* to the coiled pipe 1 and is directed downward in the reservoir *h* into the annular space between tubes 4, 8 wherein it is finally heated and rises between pipes 5, 8 to the reservoir and is discharged at 10. Straight close-ended pipes 3 may assist the final heating.

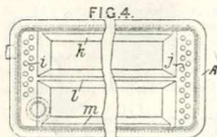
19,547. May, S. Aug. 29.



*Portable liquid-heaters.*—A container A separated from a heating-chamber I by insulating-means such as asbestos is connected to a coil G within the heating-chamber. The cocks B, K, controlling the

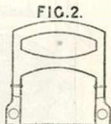
flow of water and gas respectively, are simultaneously operated, and the rate of flow of water may be controlled by a cock C on the heating-coil. A pilot light M is also provided.

20,669. Nanquette, L. Sept. 12.

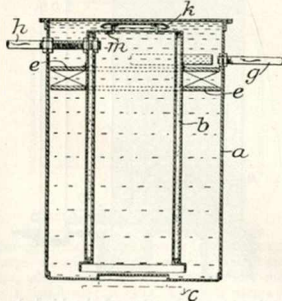


*Boilers.*—Oil for circulating in a heating system is heated in a boiler with a return flue and formed in cross-section as shown in Fig. 2, the faces of the flue being curved.

*Heating liquids.*—A device for heating liquids by means of circulation of heated oil is placed in a tank A and consists of headers *i, j* perforated by tubes and connected by portions *k, l, m*.



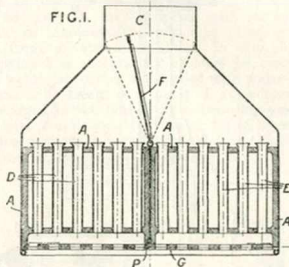
20,728. Berry, A. F. Sept. 13.



*Heating water.*—A cylindrical diaphragm *b* serves as guide for an annular movable partition *e*, so constructed as to be of slightly lesser specific gravity than water. The top of the cylindrical diaphragm may be closed by a cover *k* which normally has a tendency to rise, being kept in place by lugs *m*. On drawing-off hot water from the pipe *h*, cold water enters at *g* and spreading above the partition *e* causes it to descend; the cover *k* closes, and thus the entering water is kept separate temporarily from the hot water. On the draw-off ceasing, the partition *e* gradually rises

and, the cover *k* lifting, circulation takes place in the usual way. The tank *a* may be heated itself, as at *c*.

21,007. Haden, W. N., and Haden, C. I., [trading as Haden & Sons, G. N.], and Adlam, T. N. Sept. 17.

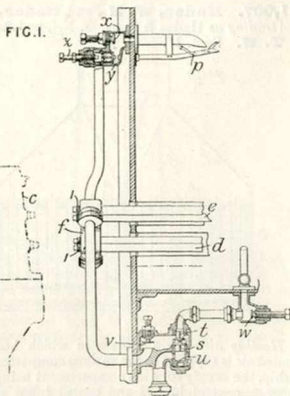


*Heating air.*—In a system in which heated or cooled air is supplied to the various compartments of a ship, the supply for each compartment being under separate control, heated and cooled tubes are provided in connexion with each compartment through either or both of which the air is delivered. As shown in Fig. 1, the apparatus for each compartment comprises bell-mouthed tubes *D, E*, externally cooled and heated respectively, which are contained in a divided casing *A*, and have an insulating partition *P* between them. The tubes *D* are cooled by water which has been passed through a refrigerator, and either hot gases, or water which is preferably heated by exhaust steam, circulates round the tubes *E*. The air is supplied to the inlet *C* preferably by a fan on deck, and is controlled by a valve *F* which is connected to the valves regulating the supply of the heating and cooling media so that they are simultaneously operated. A hit-and-miss valve *G* is also provided. In ships which pass through warm and humid climates, all the air is passed through a central cooler to extract the moisture. Either the heating or the cooling means may be used alone where circumstances render the other unnecessary.

21,118. Willans, G. H., and Peacock, J. A. W. Sept. 18.

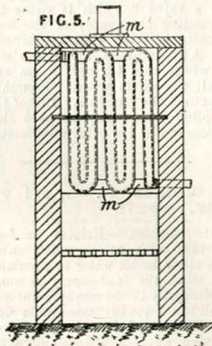
*Feed-water, heating.*—Relates to feed-heating tubes provided with valves which automatically operate to allow boiler water to circulate through the tubes when the feed-supply is stopped, and consists principally in the employment of separate valves which are readily removable from their casing. Feed is supplied to the U-tubes *e, d* placed in the smoke-tubes of a locomotive boiler and opening into a divided header *f* in the smoke-box through a check valve *s* upon which rests a second check valve *t* controlling the passage of water to the tubes from the bottom of the boiler. The

seating of the check valve *s* is formed on a tubular sleeve *u* secured in the valve box by screwing. Shut-down valves *v*, *w* are provided on both sides of the check valves. Water enters the boiler



through a valve box containing a shut-down valve *x* and a non-return valve *y*, which may be held open by a screwed spindle *z*. The delivery pipe opens above a spray-plate *p*. Plugs *l* are provided in the header *f* and also, if necessary, in the blast pipe *c*, to afford access for cleaning the tubes.

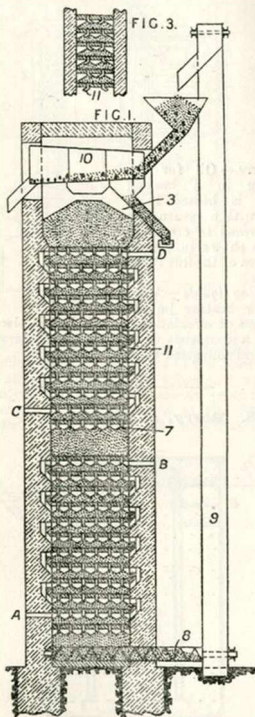
21,597. Lord, G. S., and Barlow, P.  
Sept. 25.



*Slab-form boilers.*—A boiler heated in a furnace or by steam or electricity comprises, when assembled, a sinuous flat water-space, the undulations of which

are connected together at the top and bottom by connexions *m*. The boiler can be readily taken into two parts along a central joint or, in one form, by separating the two sides of the water-space at its edges.

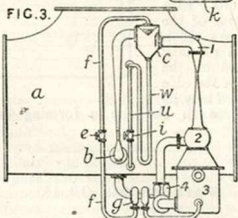
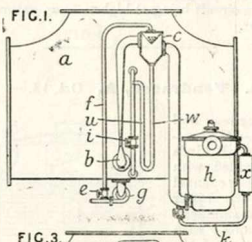
21,739. Niewerth, [née Vliex], A. Sept. 26.



*Heating air.*—Apparatus of the kind described in Specification 23,126/98 for heating air for furnaces comprises a shaft having a number of superposed perforated floors and chambers through which falling sand passes and is first heated by hot waste-gases or gases produced by direct combustion and subsequently transfers its heat to air that is passed over it. The sand passes from the reservoir 3, Fig. 1, into the upper system of chambers through holes or tubular passages 11 in the floors where it is heated by the hot gases entering at C and finally leaving at D after circulating over the conical heaps of sand which accumulate on the floors. From the

upper system of chambers the sand passes into a reservoir or sealing-chamber 7 separating the upper system of chambers from the lower systems. The air to be heated enters the lower system at A and after circulating over the hot sand escapes at B. A reservoir for sand is arranged below the lowest floor of the lower system of chambers from which the sand is removed by a screw 8 and conducted by an elevator 9 to a rotary sieve 10 above the reservoir 3. The tubes in the floors may be superposed or staggered and may be bent as shown in Fig. 3. The tubes may also be made circular or square or any other shape. Instead of sand, any other suitable material such as brick-dust, siliceous particles, or gravel-like substances may be used.

21,890. Morison, D. B. Sept. 29.

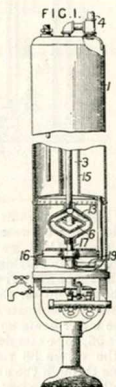


*Feed-water, heating.*—In order to obtain a variable or large air-withdrawing capacity in steam-condensing plant in which aerated vapour is withdrawn from a condenser *a*, Fig. 1, by a steam-jet *b* discharging into a heater *c*, which is evacuated by an air-pump *h*, and is supplied with water of condensation by a pipe *f*, the temperature of the water admitted to the heater is regulated by delivering it from the heater through a water-sealed looped pipe *w* or other control by which it can be delivered, as by manipulating a valve *i* in the pipe *u*, either above or below or in regulated proportion both above and below the condensing-surface, so that the water may be cooled to any desired extent before it is returned to the heater by the pump *g* for water of condensation. A valve *e* in the pipe *f* controls the quantity of water

supplied to heater. The air-pump *h* is supplied with a regulated quantity of cooled water by means of a cooler *x* and a valved pipe *k*. A reciprocating pump may be used for withdrawing and circulating water of condensation and may be coupled with the air pump *h* in the manner described in Specification 5089/09, [Class 32, Distilling &c.]. A rotary mechanically-operated air-expelling device may be used as an air-pump, and, if suitable for the purpose, may also deal with the surplus water of condensation from the pump *g*. In the form of apparatus shown in Fig. 3, the air-pump *h* is replaced by a steam jet ejector 1 and water jet ejector 2, supplied with water from a tank 3 by means of a pump 4. Condensate is discharged to the tank 3 by a two-stage pump *g*, the pipe *f* supplying the heater being connected to the first stage pump. Specification 23,140/07 [Class 102, Pumps &c.], is referred to.

22,061. Bastian, W. B. Sept. 30, 1912, [Convention date].

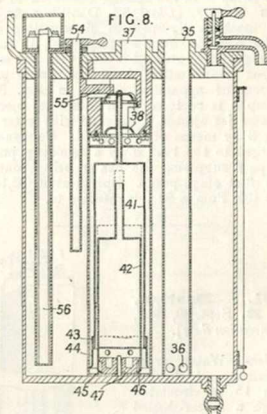
*Boilers.*—Water from a chamber 1 having a flue 15 is circulated through a saucer-shaped boiler 6 from which it rises through radial connexions 13, either formed as passages or by separate tubes, to a central pipe 3 connected to the main outflow 4. The whole is heated by a burner 16, held in position by the branches of the connecting-pipe 17, 19.



22,210. Anderson, J. Oct. 2.

*Heating liquids.*—A part only of a bulk of liquid is heated to a predetermined temperature and then permitted to re-enter the main vessel, a fresh supply then occupying the heater, the intermittent operations continuing until the whole bulk is heated. The valve or valves governing communication between the heater and the main vessel are operated by an air chamber in the heater which sinks at lower temperatures, but is buoyant at the predetermined temperature. The valve or valves may regulate the outflow of hot water from the heater, or the inflow of colder water, or both, and the sectional heater may be within or separate from the reservoir. Examples of these modifications are described. Fig. 8 shows a practical adaptation of a separate heater. The hot-water outlet 37 is controlled by balanced valves 38 operated by a float 41, open at the bottom and

surrounding an inner air chamber or float 42 open only at the top. The outer float 1 as weights 43 and a tele-copic sleeve 44 for adjustment. In operation, the outer float and valves lift, but the

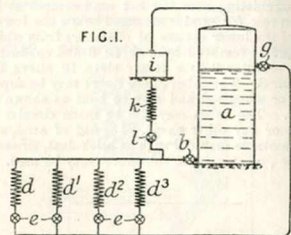


inner float 42 remains down until water enters the annular space between the floats and lifts the inner float also. Cold water flows in from the inlet 35, 36, and, on reaching the floats, the air contracts and the inner float rises until the flange 45 meets the shoulder 46 on the weight 47. Further cooling causes both floats to sink and close the valves. As the water heats up under the operation of the heater 56, for example an electric heater, the floats and the valves 38 rise again, and the hot water escapes through the outlet 37. Provision is made for holding the valves down during adjustment, by a finger 55, the spindle 54 of which is hollow and can contain a thermometer. The apparatus may be used in conjunction with, or in place of, an ordinary range-heated hot-water supply system.

**22,875. Semmler, C.** Oct. 10.

*Heating water.*—Waste heat from a number of variable sources, for example in an iron works, from blast furnace gas, slag, hot blast stoves, puddling and welding furnaces, &c., is collected by a heat conveyer, for example distilled water, so that a substantially uniform supply can be obtained for power, and other purposes. In the apparatus illustrated diagrammatically in Fig. 1, the heat is collected by the liquid conveyer which is forced by a pump *b* through a circuit including an accumulator *a*, transfer apparatus *d*, *d'*, *d''*, *d'''*, connected in parallel and branch and main reducing valves,

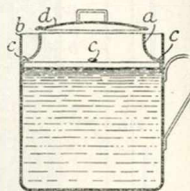
e.g. for preventing the formation of steam except in the accumulator. In another form, two sets of transfer apparatus connected up in two separate



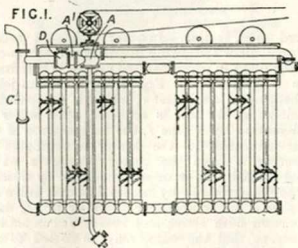
circuits are provided for the different sources of heat, one circuit being at higher temperature than the other.

**23,132. Vondracek, A.** Oct. 13.

*Boiling-pans and the like.*—Heating-vessels of all kinds are provided with an overflow channel within the upper edge *b* communicating by holes *c* with the interior of the vessel. An additional channel may be formed on the exterior of the edge *b*. A lid *d* may be provided to fit the rim *a* forming the inner channel.



**23,371. Park, G. M.** Oct. 16.

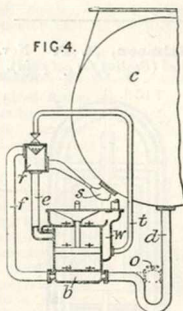


*Feed-water, heating.*—To prevent "sweating" of the tubes of a fuel-conomizer, and to promote the



water circulation therein, water is drawn from the discharge end of the tubes and supplied to the inlet end by inserting, in a pipe connecting the ends, a valve operated so as to set up in the pipe an action similar to that of an hydraulic ram. The pipe connecting the ends of the economizer shown contains a piston valve A, which is reciprocated by the gearing of the cleaning scrapers, and a non-return valve D. Upon the sudden opening of the valve A, hot water passes through the non-return valve into the feed-pipe C. When the valve A is closed, the greater pressure of the cold feed closes the non-return valve, and the water in the space A<sup>1</sup> between the valves flows away through a pipe J, which contains a non-return valve to prevent the admission of air.

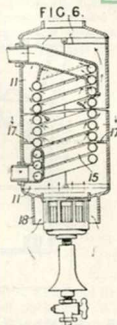
**24,192. Morison, D. B.** Oct. 25. [*Cognate Application, 3/14.*]



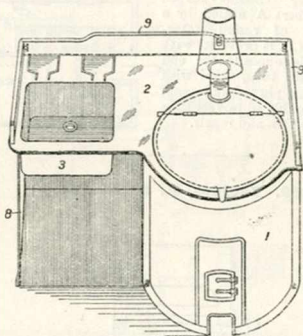
*Feed-water heating.*—Relates to steam condensing plant wherein aerated vapour is withdrawn from the condenser *c* by means of a steam jet *s* discharging into a feedwater-heater *r*. The invention consists primarily in withdrawing heated water and aerated vapour from the heater by means of one or more reciprocating pumps *b*, the water and vapour being delivered either together, as by a pipe *e*, above the bucket or buckets, or separately, as by pipes *e*, *f*, on opposite sides of the bucket or buckets, in each case with or without condensate from the condenser. The water and vapour may also be led to separate pumps below the buckets, in which case the pump dealing with the vapour is cooled by water circulating through a water-cooler. The pipe *d* leading condensate to the pump may be formed with a water seal, a by-pass valve *o* being provided for use when it is desired to throw the seal out of action. The water supplied to the heater *r* through the pipe *t* may be condensate derived from the hot-well *w*. The pumps may be of the valveless-bucket or Edwards type. Specifications 23,140/07, [Class 102, Pumps &c.], and 1161/09, [Class 32, Distilling &c.], are referred to.

**25,067. Ackroyd, J. H.** Nov. 3.

*Water-tube boilers.*—A water-coil 15 is arranged as shown above a gas burner of special construction in a heating-chamber 11, which is provided with a door and with an internal baffle 17.



**25,104. Haighton, Ltd., R., and Haighton, A.** Nov. 4.



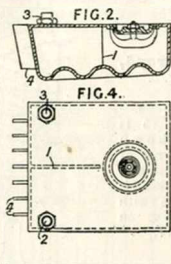
*Washing-boilers.*—A washing-boiler 1 is combined with a sink by means of a cover 2 carrying the sink 3. The cover has a splash rim 9, and is supported at the sink end by a frame 8.

**25,745. Hartley & Sugden, and Fox, S.** Nov. 11.

*Block form boilers.*—A vertical midfeather 1 extends approximately half-way across the boiler, the inlet 2 and outlet 3 being on opposite sides. The bottom may be provided with transverse corrugations, and the back may slope as shown in Fig. 2 and have heating-ribs 4.

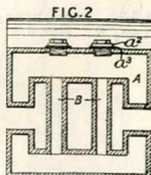
(For Figures see next page.)

25,745.

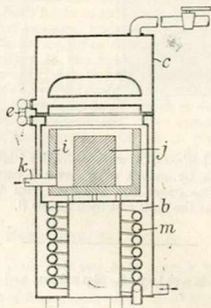


25,866. **Rutter, J. M.** Nov. 12. [Addition to 15,193/12.]

*Boilers.*—A boiler of the type described in the parent Specification, having channel-shaped members A united by a stack of round water-tubes B, is provided with a hole opposite the end of each tube, fitted with a screw plug  $a'$  and packing-means  $a''$  to facilitate inspection and repair.



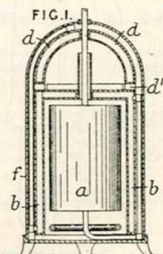
26,259. **Ionides, A. C.** Nov. 15.



*Internally-fired boilers.*—Relates to apparatus of the kind in which a self-burning gaseous mixture at a pressure slightly above atmospheric is burnt in a closed chamber, as described in Specification 15,455/9, [Class 126, Stoves &c.], and consists in providing a combustion chamber of refractory material surrounded by a jacket through which the liquid to be heated is

passed. The water-heater shown consists of two cylindrical chambers  $b, c$  connected by an external pipe  $e$  formed as a swivel joint, which allows the upper chamber to be swung aside to afford access to the combustion chamber in the lower chamber. The water space in the lower chamber is annular and is contracted at its upper part to accommodate the combustion chamber, which consists of a fire-brick cylindrical shell  $i$  containing a core  $j$ . The pipe  $k$  supplying the combustible mixture enters the combustion chamber tangentially. The products of combustion escape through a tubular coil  $m$  in the lower part of the chamber  $b$ . The water passes through the heater in an upward direction. The constituents of the combustible mixture are maintained at their correct proportion by apparatus such as is described in Specification 21,112/11, [Class 135, Valves &c.], and the mixture may be passed through a device such as is described in Specification 23,350/13, [Class 86, Mixing &c.], to prevent flame from passing back into the supply pipe.

26,331. **Stimson, E. F.** Nov. 17. No Patent granted (Sealing fee not paid).

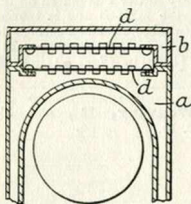


*Internally-fired boilers.*—A gas-heated water-heater for use in a hot-water circulation-system consists of a boiler  $a$ , Fig. 1, preferably of the kind described in Specifications 29,011/11 and 52/12, mounted within a cylindrical water jacket  $b$  having an opening at the top to allow the combustion products to pass into the interior of a second dome-shaped water jacket  $d$ . A casing  $f$  may be provided around the jackets to form a further flue space  $i$  to which the combustion products pass through openings  $d'$  at the bottom of the jacket  $d$ . The return water passes through the jackets  $d, b$  in succession before entering the boiler  $a$ . In a modification, the casing is dispensed with and the jacket  $d$  is extended downwards around the jacket  $b$ .

26,332. **Stimson, E. F.** Nov 17. No Patent granted (Sealing fee not paid).

*Boilers.*—In a boiler of the kind described in Specification 28,494/12 for use in a hot-water circulation system, the flue walls of the casings  $a, b$ , in which water is preheated, are made of thin

copper or other metal plates *d* having lugs or ribs on both surfaces. The plates are detachably

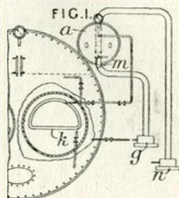


secured to the casings, the inspection covers in the tops of the casing being dispensed with.

**26,558. Makin, E.** Nov. 19.

*Feed-water, heating.*—In a boiler having a primary generator, such as a coiled water-heating

tube *h* in its flues, as described in Specification 28,689/09, and having a pressure-header *a* for supplying water to the primary generator as described in Specifications 20,691/12 and 20,692/12,

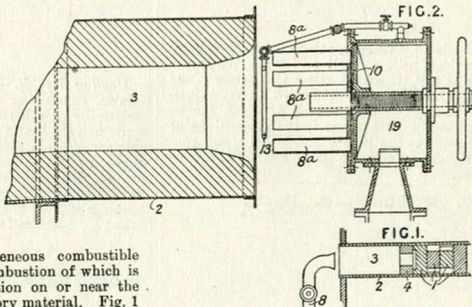


the header is adapted to serve as a mud drum by providing it with a blow-off cock *m*. Water is drawn from the bottom of the boiler and forced into the header by a pump *g*. Fresh feed is supplied to the header by a pump *n*.

**26,769. Kirke, P. St. G., and Boncourt Surface Combustion, Ltd.** Nov. 21.

*Internally-fired boilers.*

—Feed-water heaters and liquid-heaters generally of the kind wherein the heat of combustion can pass to the liquid only through the plates or walls of the liquid container are heated by the combustion of gas and air introduced, in proportions necessary for full and complete combustion, into a mixing-chamber wherein combustion begins, and wherefrom issues a homogeneous combustible mixture of gas and air, the combustion of which is completed as surface combustion on or near the surfaces of masses of refractory material. Fig. 1 shows a boiler tube 2 containing masses 1 of refractory material. Gas is admitted to the part 3 of the tube 2 by a valved pipe 8, and air also enters the tube freely, the draught being produced by suction. The part 3 forms a mixing-chamber wherein combustion begins, and the mixture, after passing through the diaphragm 4, burns on the surfaces of the refractory material 1. The invention is further described in connexion with a Lancashire boiler the flue 2 of which is lined with refractory material 3 and fired by gas and air



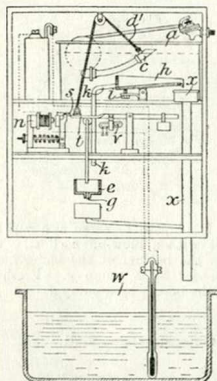
similarly introduced. The gas is supplied by a box 19 and nozzles 8<sup>a</sup>. The box 19 contains a valve 10 the spindle of which is hollow and serves as an inspection orifice. A pilot burner 13 is attached. Additional tubes or the like may be provided, and may contain refractory material for heating the same or another liquid container. Specifications 29,430/09, [Class 51 (i), Furnaces and kilns, Combustion apparatus of], 4362/10, and 11,958/13 are referred to.

**28,797. Anger, R.** Dec. 13.

*Water supply.*—The temperature in a vessel in which water is heated is regulated by adding a quantity of cold water, the amount of which can be controlled, when the temperature of the heated water reaches a certain point. The water is supplied from a tank *a*, provided with a ball

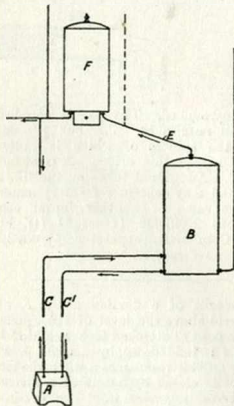
cock, by means of a flexible nozzle *c*, which is normally held above the level of the water in the tank *a* by a cord *a'* attached to a weighted lever *l*. The lever *l* is held down by a catch *g*, which is released by an electro-magnet *n* when the circuit of the magnet is closed by means of a thermometer in the water-heating vessel *v*. The nozzle *c* then falls, delivering water to a tank *h* which delivers it

to the vessel *w* through a pipe *x*. At the same time, the circuit of the electro-magnet is broken by a tilting tube *v*, containing mercury and attached to the lever *t*. From the tank *h*, a drain-



pipe *k* leads to a vessel *e*, attached to the cord *d'* and provided with a small outlet *g*. When the vessel *e* is full, its weight raises the nozzle *c*, and the lever *t* re-engages with the tank *h*. By adjusting the inclination of the tank *h*, which can be done by means of a screw *i*, the proportions of water flowing to the pipe *n* and vessel *e*, and consequently the amount of water delivered, can be regulated.

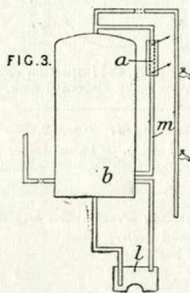
28,847. **Wilkinson, G.** Dec. 15.



Heating water.—In an ordinary domestic hot-

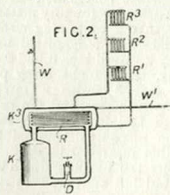
water system comprising a storage tank *B* connected by circulating-pipes *C, C'* to a boiler *A*, an electric auxiliary heater *F* is placed on the draw-off pipe *E* from the tank *B* and is thermostatically controlled. Suitable electric heating-devices and controls are described in Specifications 19,543/12 and 9041/13, [both in *Class 39* (iii), Heating by electricity].

28,932. **Weaving, R., and Ferranti, Ltd.** Dec. 15.



Heating liquids.—In apparatus for heating liquids, comprising a primary container heated electrically or otherwise, and a separate secondary container, the heater is placed near the top of the primary container in order to restrict the circulation. As shown, the heater *a* is adjustable along a pipe *m* connected to the storage tank *b* of a domestic hot-water system. In a modification, the heater is applied to the up-pipe from the fire-back boiler *l*. Specification 9930/13 is referred to.

28,942. **Jahn, K.** Dec. 15.



Heating water.—In systems of heating by hot water, the boilers or other elements where the water receives heat are made approximately equal in total volume to the radiators or other elements where the heat is given off. The invention is applicable both to systems in which the hot water is used directly for heating buildings &c. and to systems in which the water is used to heat other water. In the arrangement shown in Fig. 2, a boiler *K* is connected to a tubular or like heater *R*